

# III Copa Tortosa SuperCopa Junior

?

Competidores: 0

# III Copa Tortosa SuperCopa Junior

# Jun F -44

Competidores: 4

## Competidores

| Nº | Nombre                    | Club | 1 | 2 | 3 | 4 | Victs. | Pts. | Pos. |
|----|---------------------------|------|---|---|---|---|--------|------|------|
| 1  | Mireia LAPUERTA COMAS     | CAT  |   |   |   |   |        |      |      |
| 2  | Belen BANS JORGE          | CAN  |   |   |   |   |        |      |      |
| 3  | Mireia RODRIGUEZ SALVADOR | VAL  |   |   |   |   |        |      |      |
| 4  | Marina GARRIGA ORTEGA     | CAT  |   |   |   |   |        |      |      |

## Combates

| Comb. | Blanco                    |   |   | Azul                      | Resultado | Tiempo |
|-------|---------------------------|---|---|---------------------------|-----------|--------|
| 1     | Mireia LAPUERTA COMAS     | 1 | 2 | Belen BANS JORGE          |           |        |
| 2     | Mireia RODRIGUEZ SALVADOR | 3 | 4 | Marina GARRIGA ORTEGA     |           |        |
| 3     | Mireia LAPUERTA COMAS     | 1 | 3 | Mireia RODRIGUEZ SALVADOR |           |        |
| 4     | Belen BANS JORGE          | 2 | 4 | Marina GARRIGA ORTEGA     |           |        |
| 5     | Mireia LAPUERTA COMAS     | 1 | 4 | Marina GARRIGA ORTEGA     |           |        |
| 6     | Belen BANS JORGE          | 2 | 3 | Mireia RODRIGUEZ SALVADOR |           |        |

## Clasificación

| Pos. | Nombre |
|------|--------|
| 1    |        |
| 2    |        |
| 3    |        |
| 3    |        |

# III Copa Tortosa SuperCopa Junior

## Jun F -48

Competidores: 10

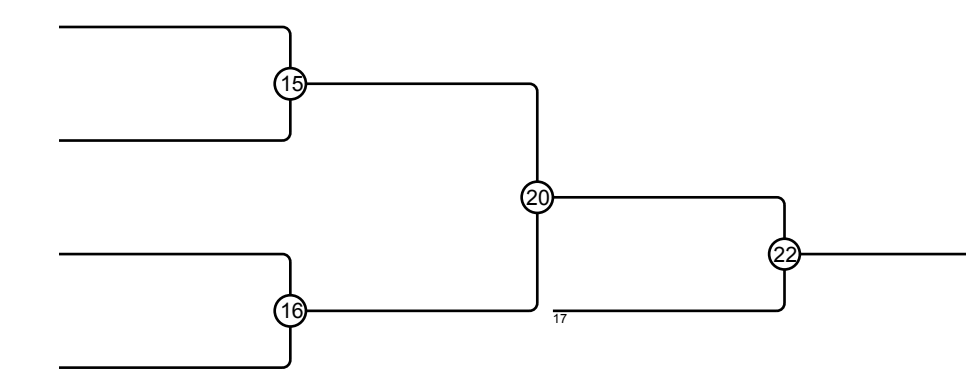
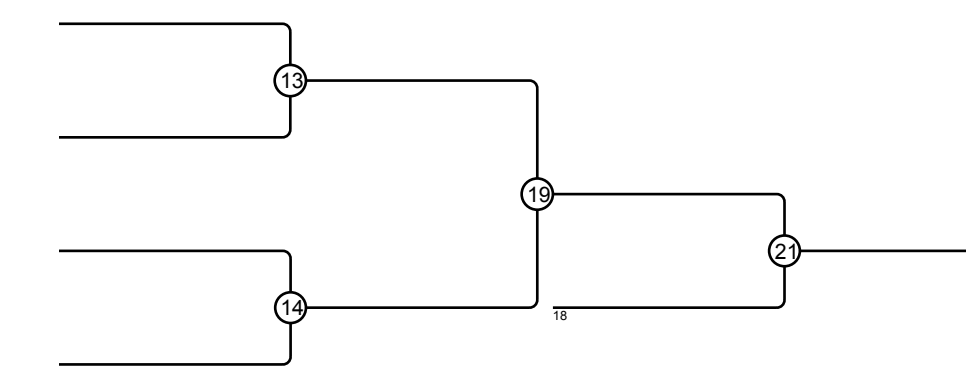
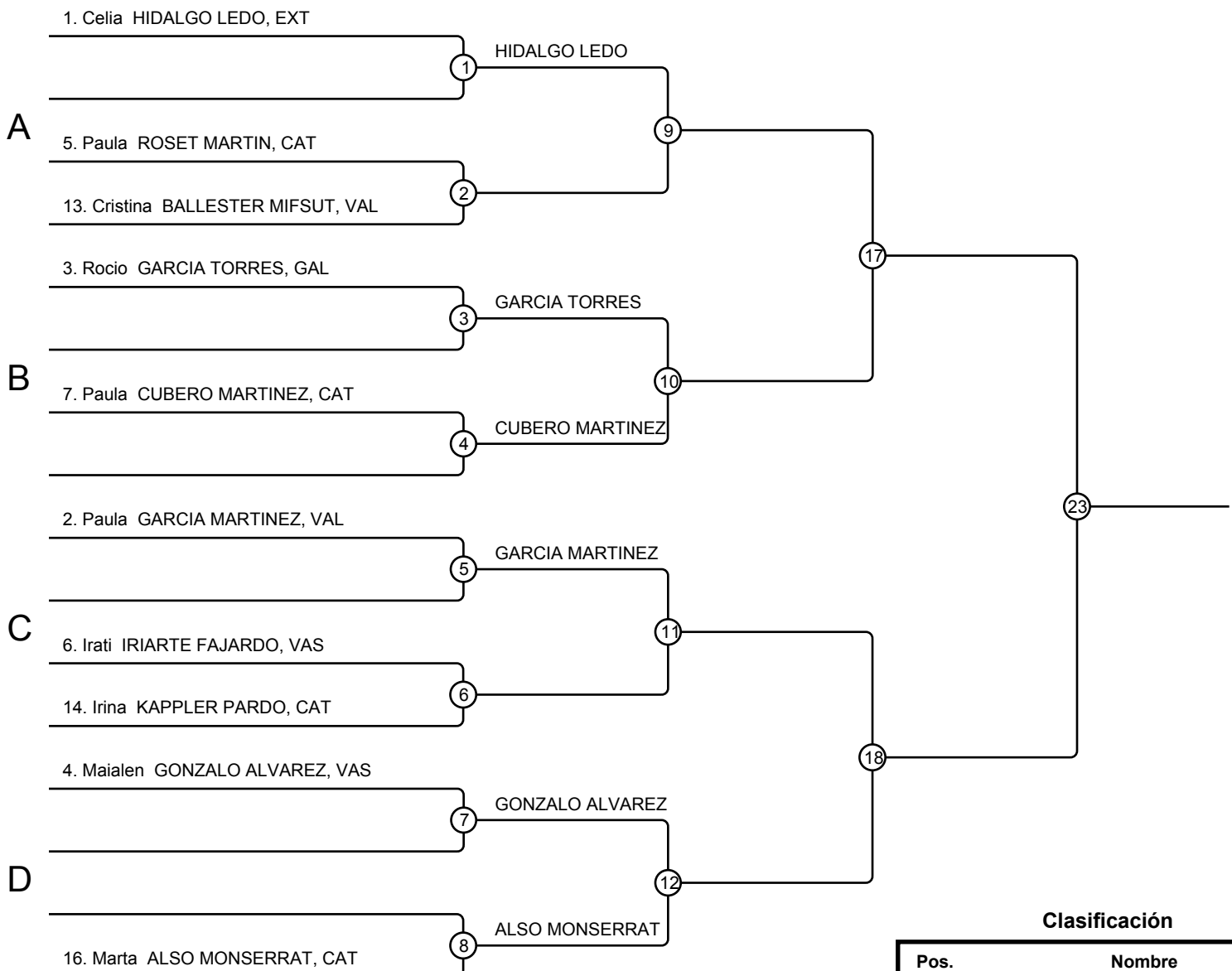

**Clasificación**

| Pos. | Nombre |
|------|--------|
| 1    |        |
| 2    |        |
| 3    |        |
| 3    |        |
| 5    |        |
| 5    |        |
| 7    |        |
| 7    |        |

# III Copa Tortosa SuperCopa Junior

## Jun F -52

Competidores: 12

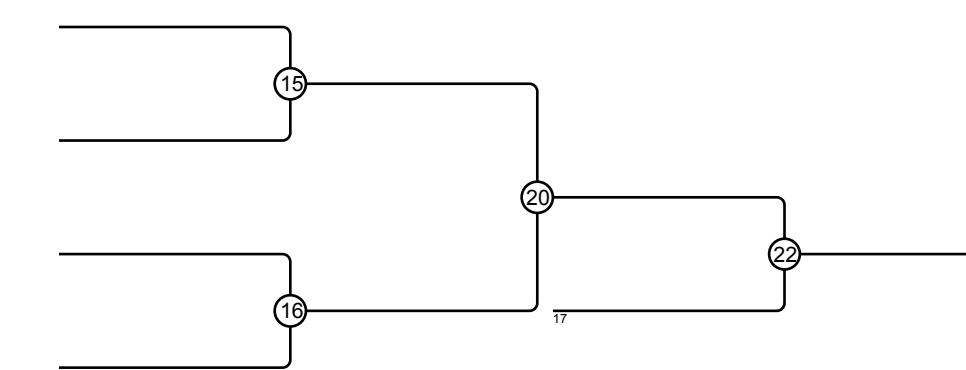
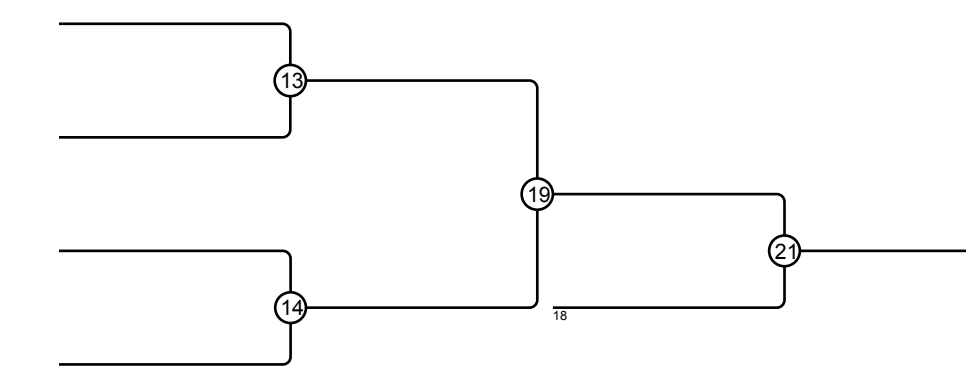
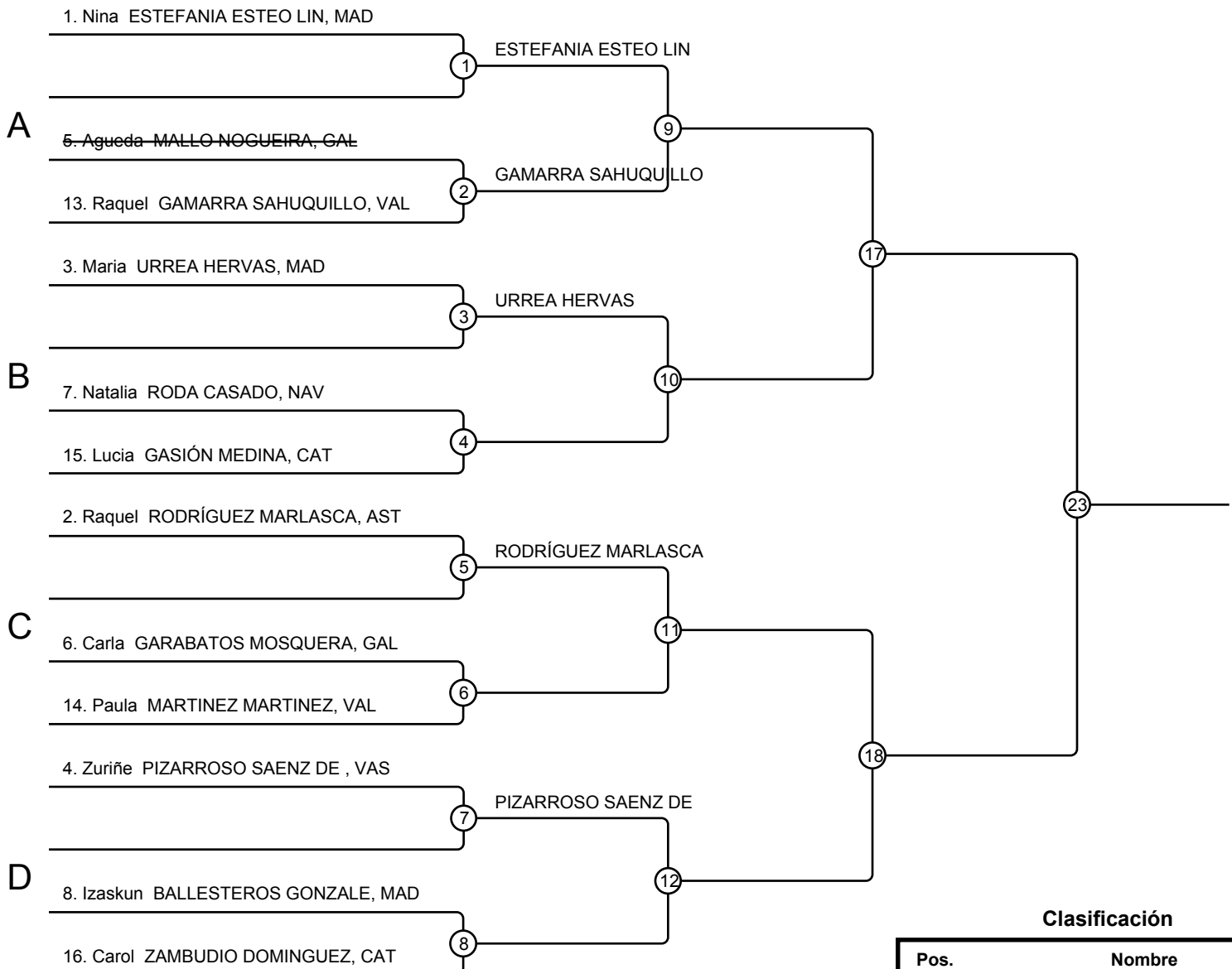

### Clasificación

| Pos. | Nombre |
|------|--------|
| 1    |        |
| 2    |        |
| 3    |        |
| 3    |        |
| 5    |        |
| 5    |        |
| 7    |        |
| 7    |        |

# III Copa Tortosa SuperCopa Junior

Jun F -57 (1/3)

Competidores: 33

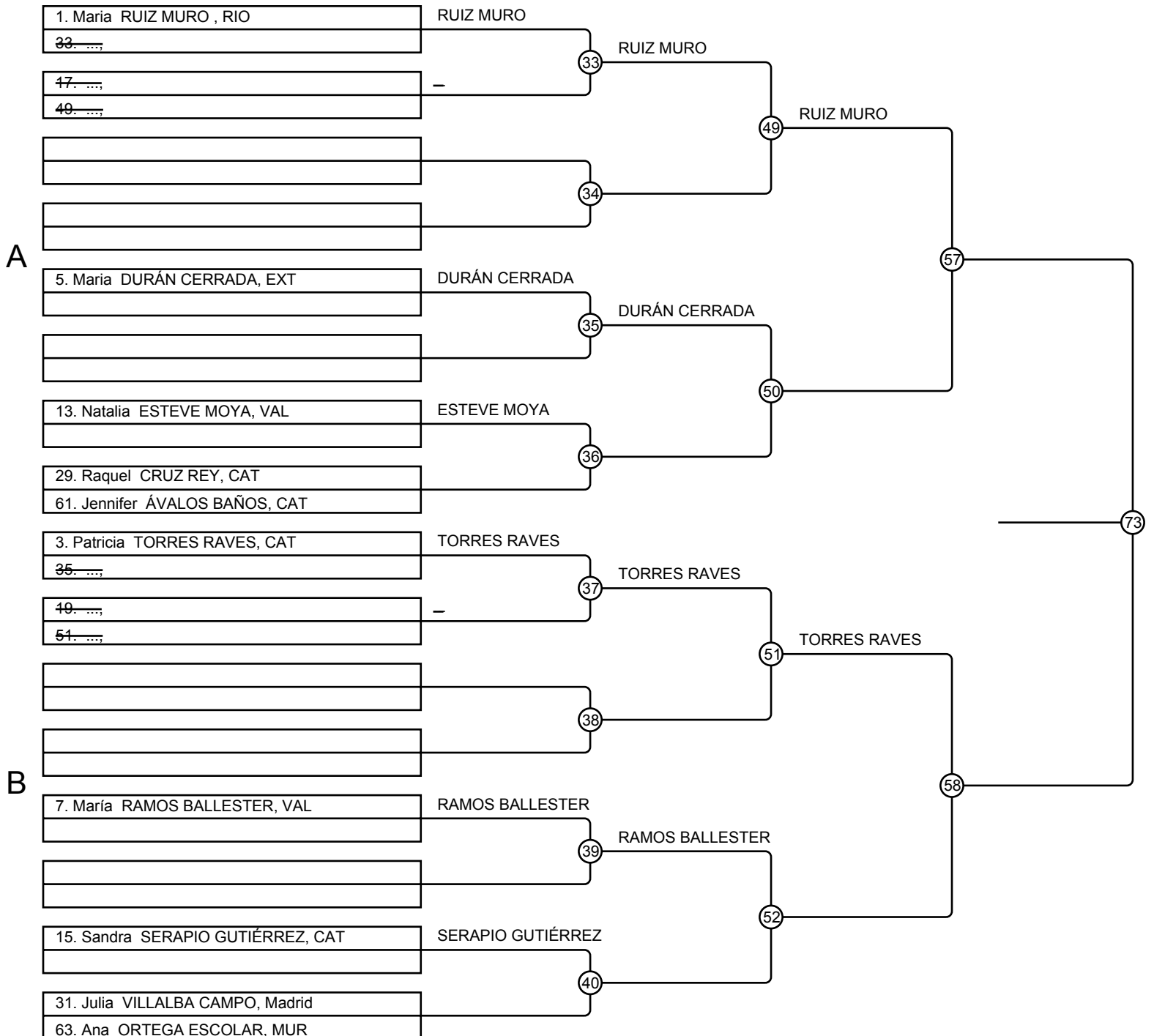

# III Copa Tortosa SuperCopa Junior

Jun F -57 (2/3)

Competidores: 33

C

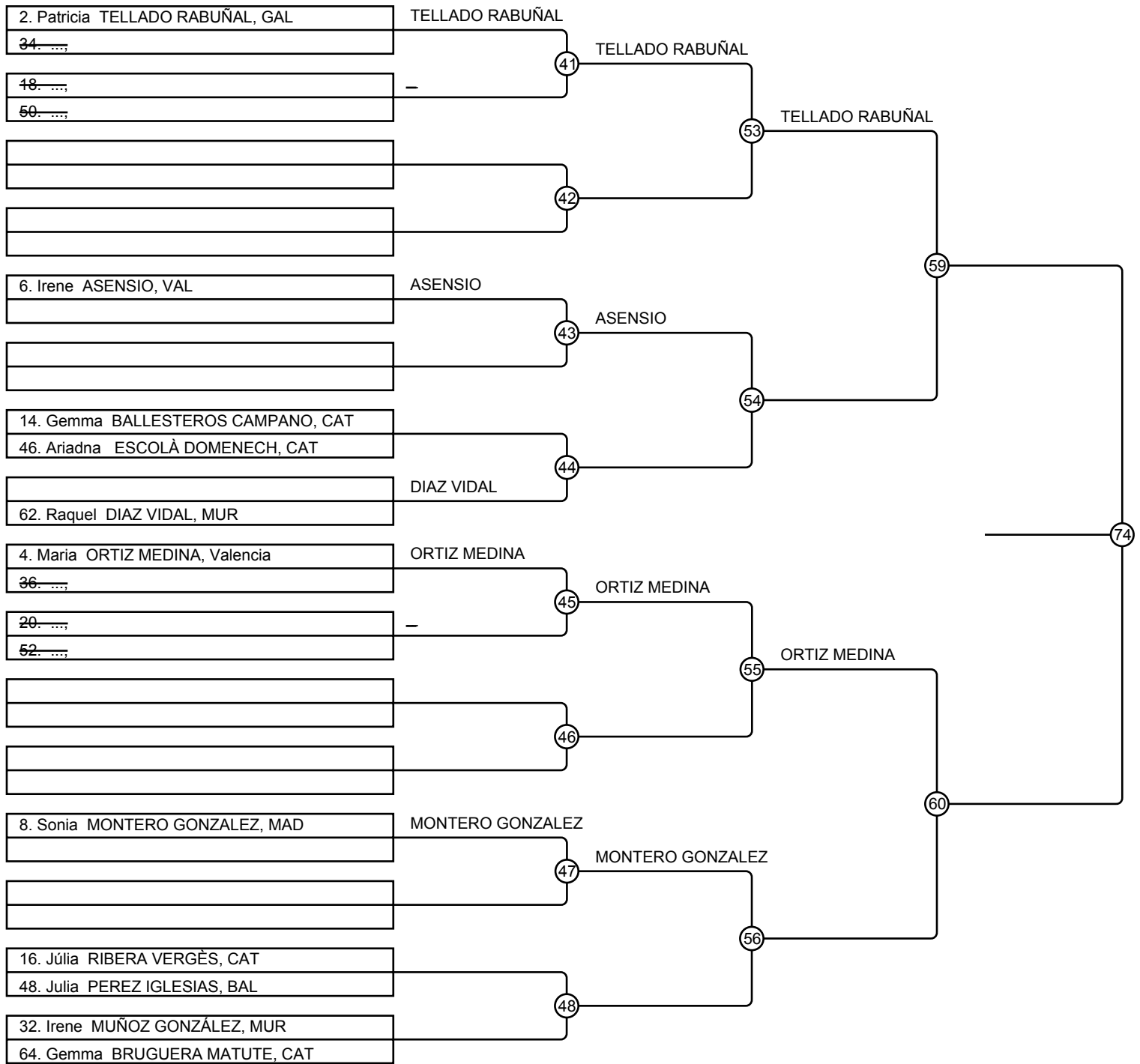

# III Copa Tortosa SuperCopa Junior

Jun F -57 (3/3)

Competidores: 33

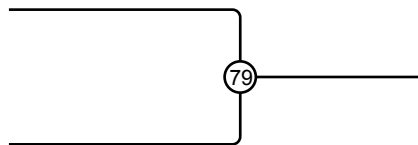
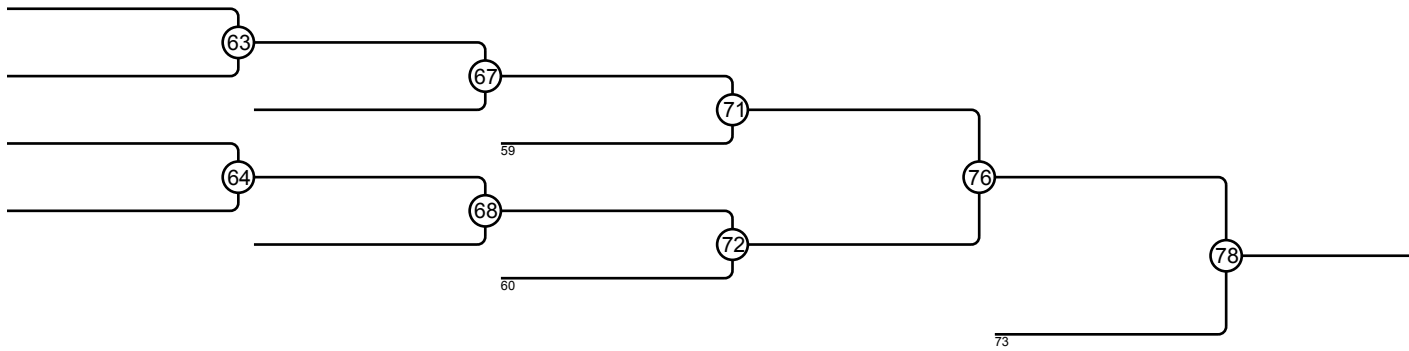
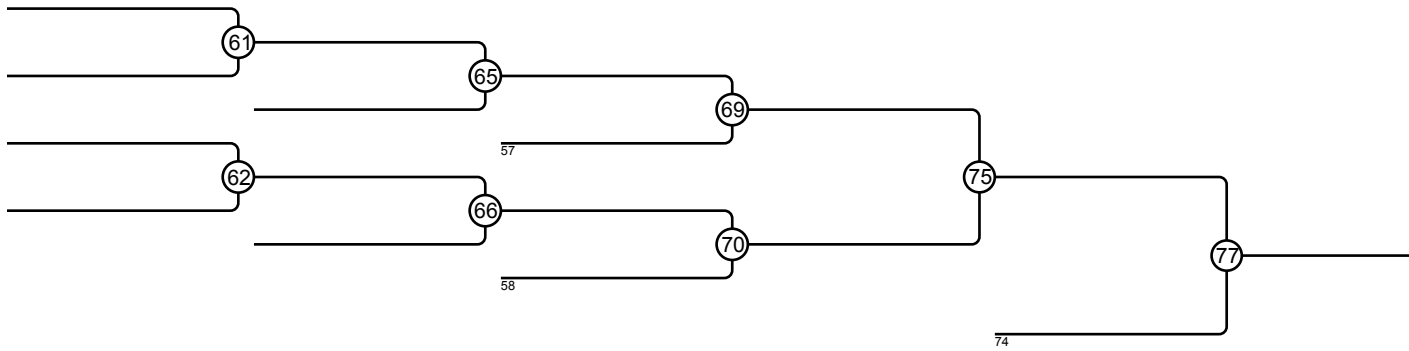

## Clasificación

| Pos. | Nombre |
|------|--------|
| 1    |        |
| 2    |        |
| 3    |        |
| 3    |        |
| 5    |        |
| 5    |        |
| 7    |        |
| 7    |        |

# III Copa Tortosa SuperCopa Junior

Jun F -63 (1/3)

Competidores: 33

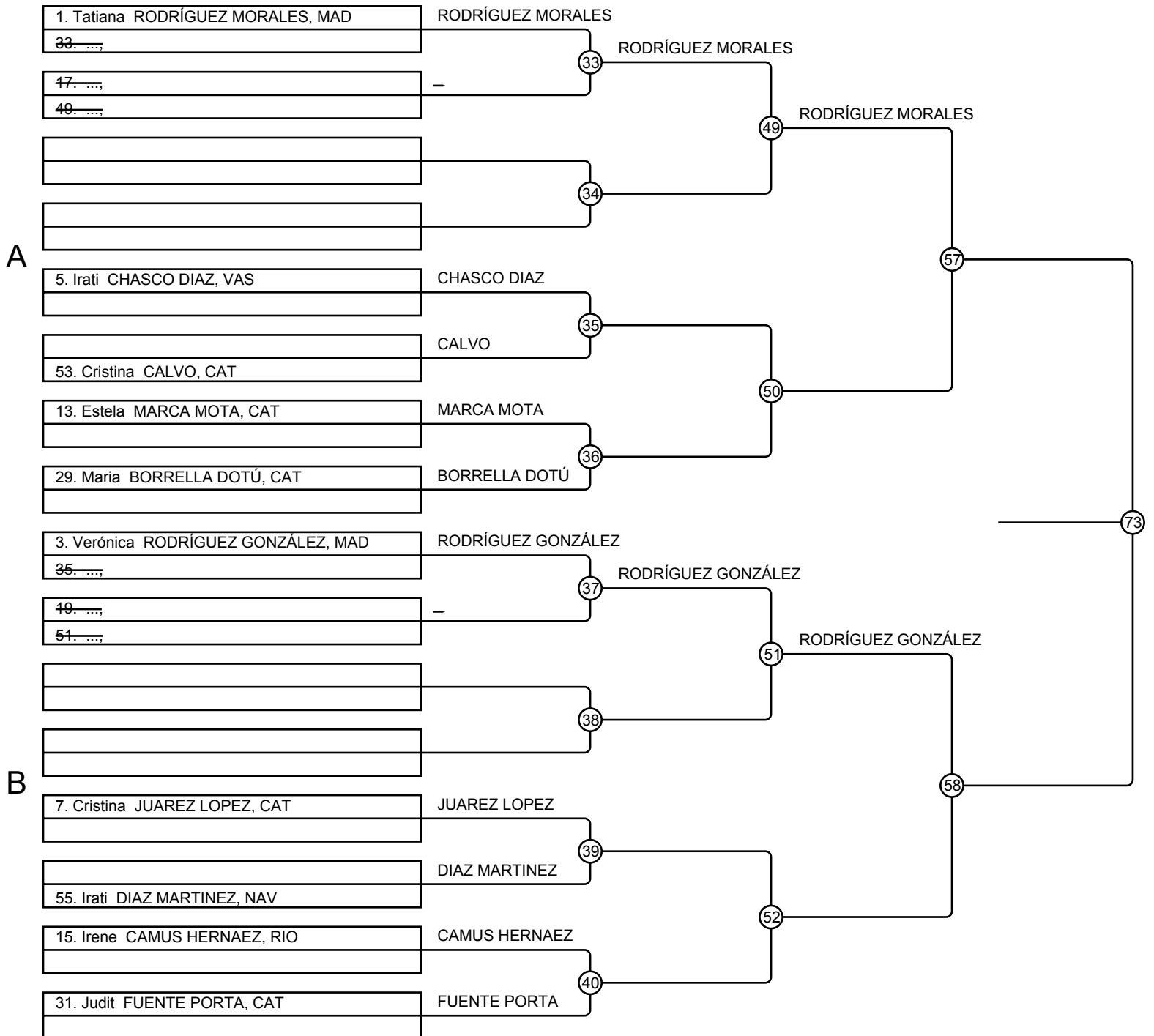



# III Copa Tortosa SuperCopa Junior

Jun F -63 (2/3)

Competidores: 33

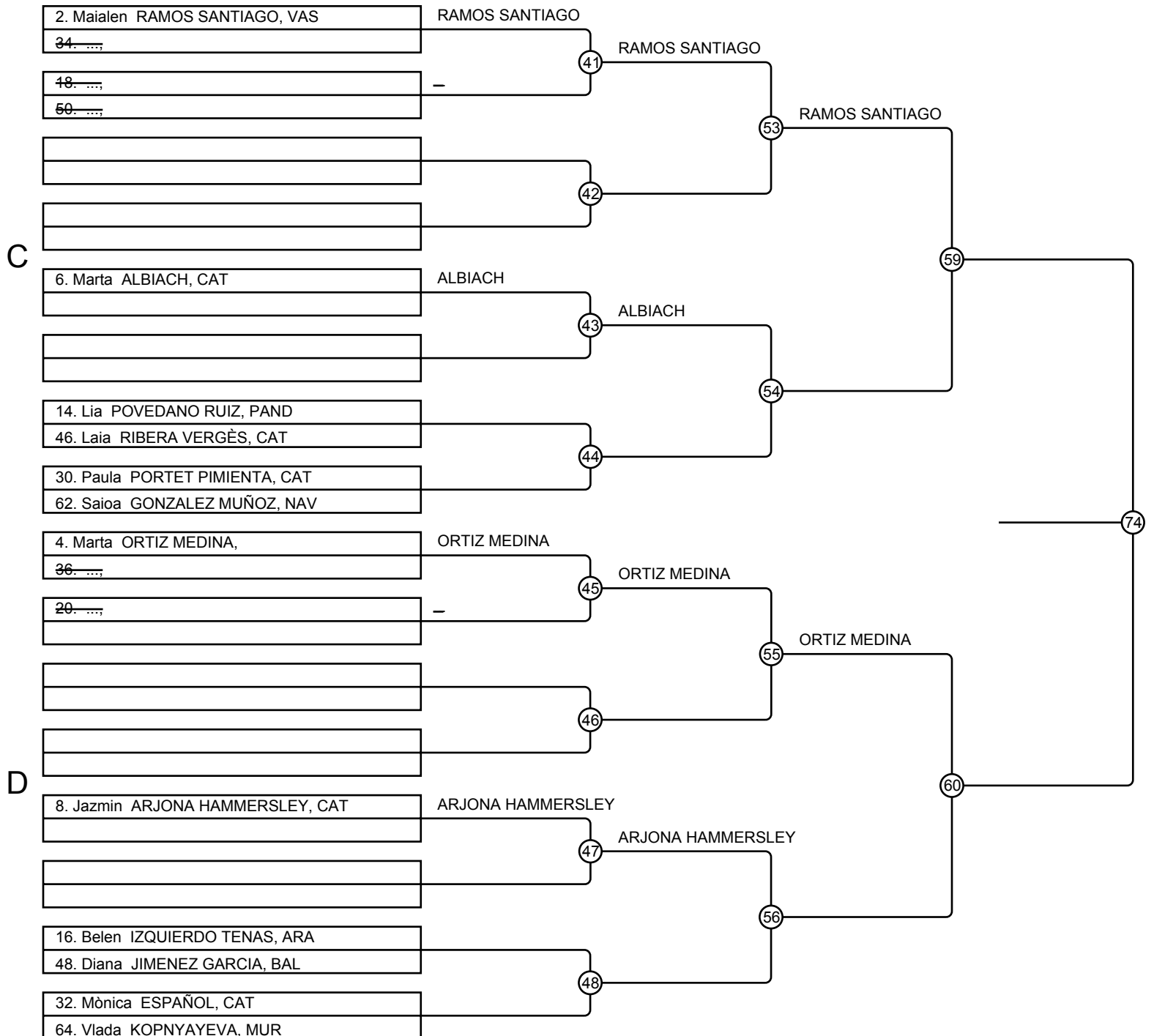

# III Copa Tortosa SuperCopa Junior

Jun F -63 (3/3)

Competidores: 33

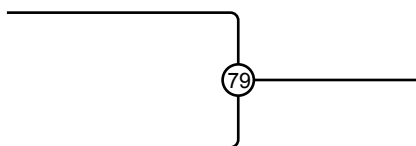
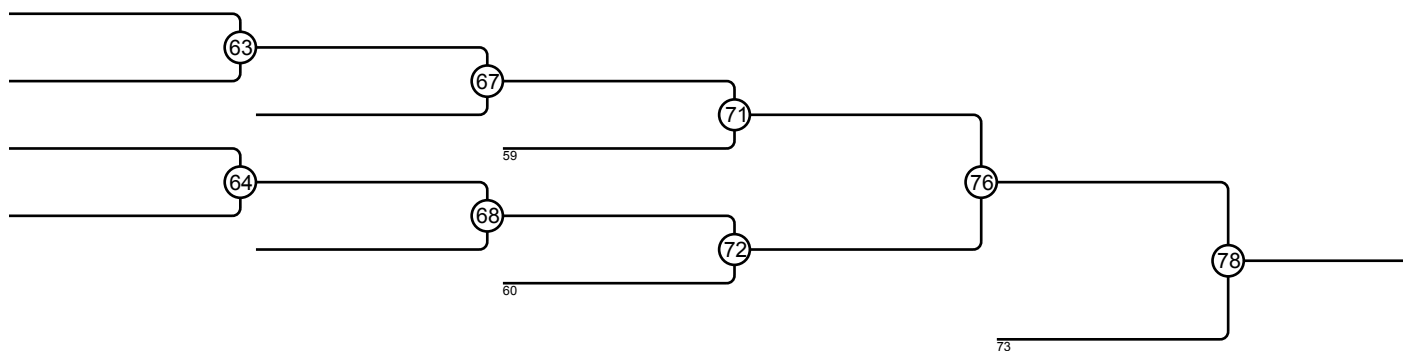
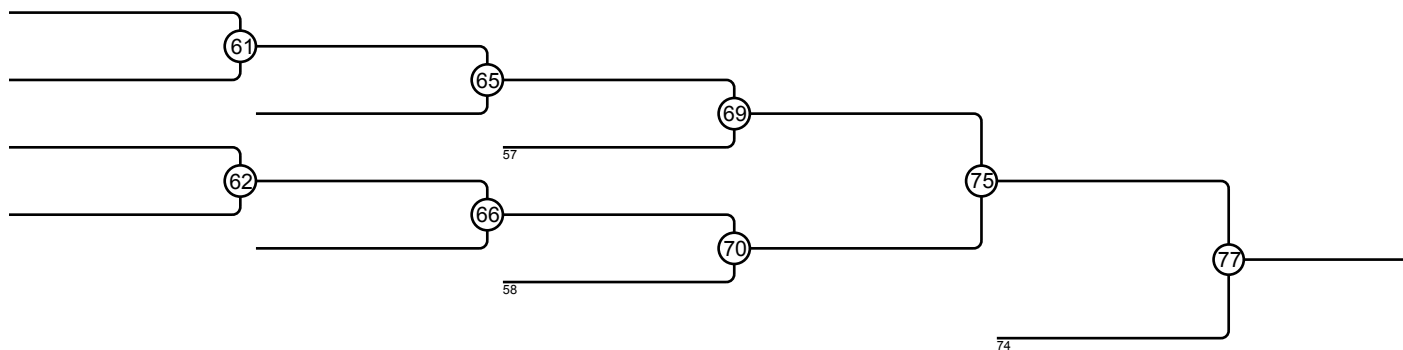

## Clasificación

| Pos. | Nombre |
|------|--------|
| 1    |        |
| 2    |        |
| 3    |        |
| 3    |        |
| 5    |        |
| 5    |        |
| 7    |        |
| 7    |        |

# III Copa Tortosa SuperCopa Junior

## Jun F -70

Competidores: 8

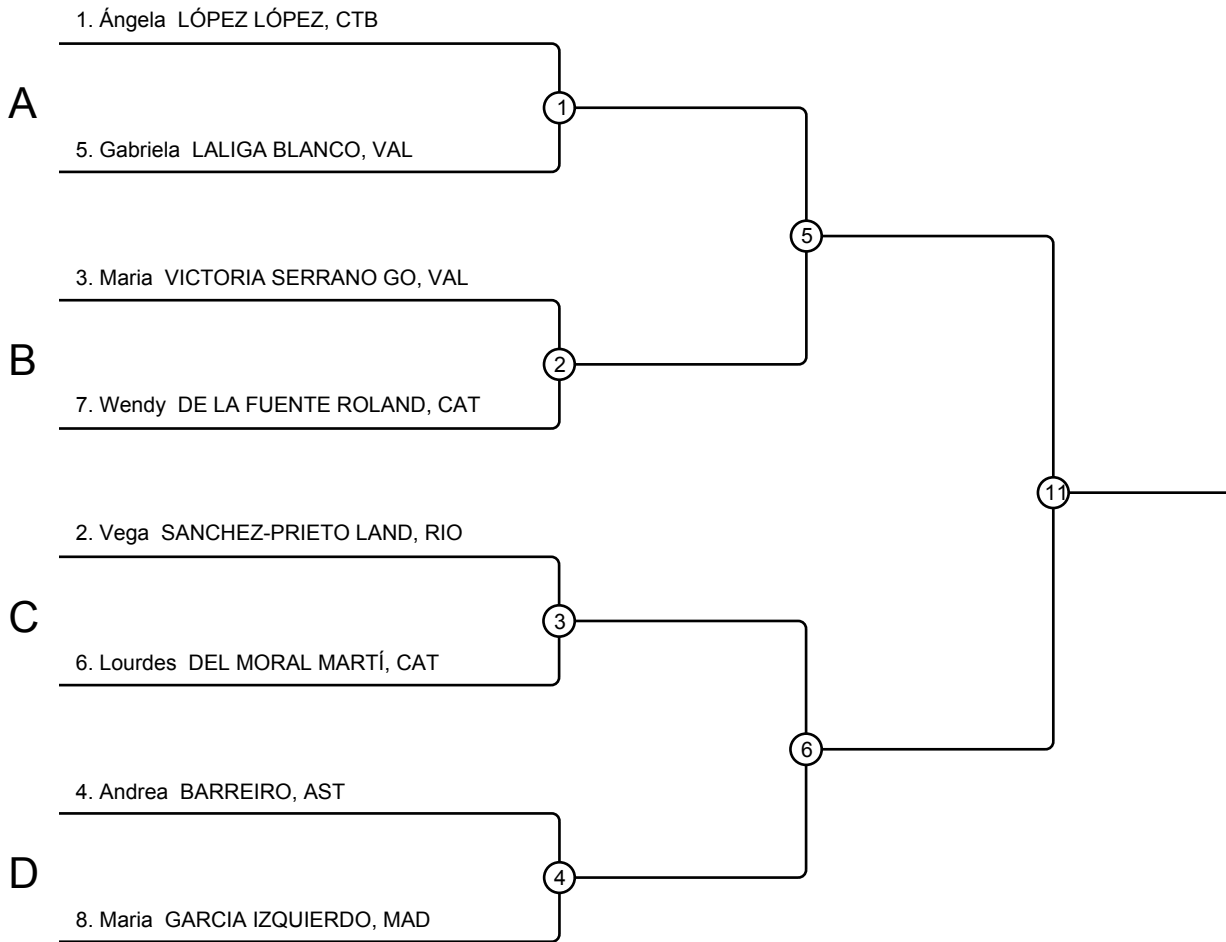

**Clasificación**

| Pos. | Nombre |
|------|--------|
| 1    |        |
| 2    |        |
| 3    |        |
| 3    |        |
| 5    |        |
| 5    |        |
| 7    |        |
| 7    |        |

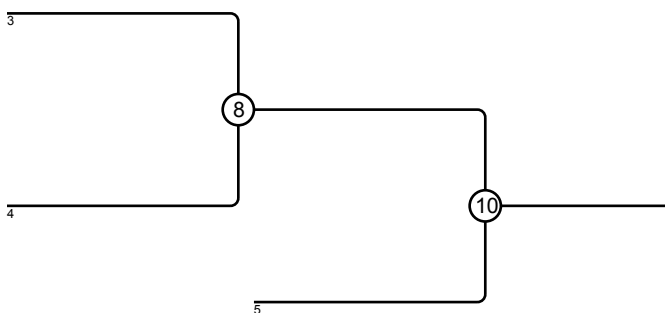
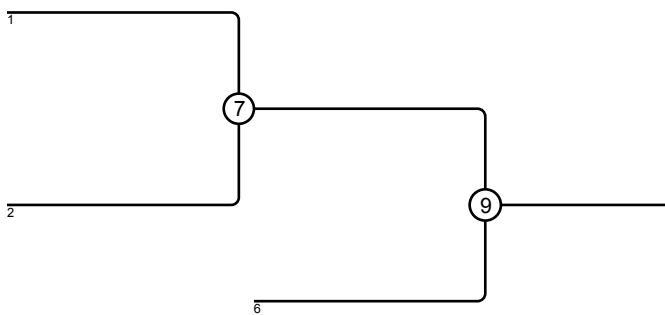

# III Copa Tortosa SuperCopa Junior

# Jun F -78

Competidores: 3

## Competidores

| Nº | Nombre                 | Club | 1 | 2 | 3 | Victs. | Pts. | Pos. |
|----|------------------------|------|---|---|---|--------|------|------|
| 1  | Aina CORNELLÀ BUJALDÓN | CAT  |   |   |   |        |      |      |
| 2  | Yolanda TORRES         | CAT  |   |   |   |        |      |      |
| 3  | Raquel DE PABLO        | ARA  |   |   |   |        |      |      |

## Combates

| Comb. | Blanco                 |   |   | Azul            | Resultado | Tiempo |
|-------|------------------------|---|---|-----------------|-----------|--------|
| 1     | Aina CORNELLÀ BUJALDÓN | 1 | 2 | Yolanda TORRES  |           |        |
| 2     | Aina CORNELLÀ BUJALDÓN | 1 | 3 | Raquel DE PABLO |           |        |
| 3     | Yolanda TORRES         | 2 | 3 | Raquel DE PABLO |           |        |

## Clasificación

| Pos. | Nombre |
|------|--------|
| 1    |        |
| 2    |        |
| 3    |        |

# III Copa Tortosa SuperCopa Junior

# Jun F +78

Competidores: 4

## Competidores

| Nº | Nombre                | Club | 1 | 2 | 3 | 4 | Victs. | Pts. | Pos. |
|----|-----------------------|------|---|---|---|---|--------|------|------|
| 1  | Cristina ALCALDE ACAZ | NAV  |   |   |   |   |        |      |      |
| 2  | Lidia YARZA OLASO     | VAS  |   |   |   |   |        |      |      |
| 3  | Miriam GARCIA CUEVAS  |      |   |   |   |   |        |      |      |
| 4  | Iara LIMA BORDOLI     | CAN  |   |   |   |   |        |      |      |

## Combates

| Comb. | Blanco                |   |   | Azul                 | Resultado | Tiempo |
|-------|-----------------------|---|---|----------------------|-----------|--------|
| 1     | Cristina ALCALDE ACAZ | 1 | 2 | Lidia YARZA OLASO    |           |        |
| 2     | Miriam GARCIA CUEVAS  | 3 | 4 | Iara LIMA BORDOLI    |           |        |
| 3     | Cristina ALCALDE ACAZ | 1 | 3 | Miriam GARCIA CUEVAS |           |        |
| 4     | Lidia YARZA OLASO     | 2 | 4 | Iara LIMA BORDOLI    |           |        |
| 5     | Cristina ALCALDE ACAZ | 1 | 4 | Iara LIMA BORDOLI    |           |        |
| 6     | Lidia YARZA OLASO     | 2 | 3 | Miriam GARCIA CUEVAS |           |        |

## Clasificación

| Pos. | Nombre |
|------|--------|
| 1    |        |
| 2    |        |
| 3    |        |
| 3    |        |

# III Copa Tortosa SuperCopa Junior

## Jun M -55

Competidores: 14

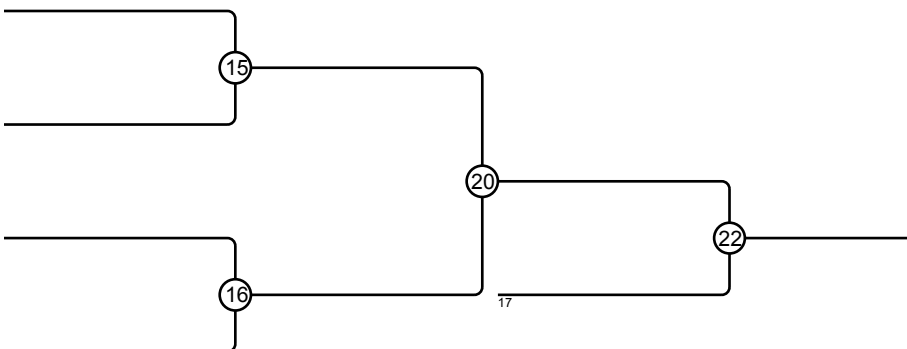
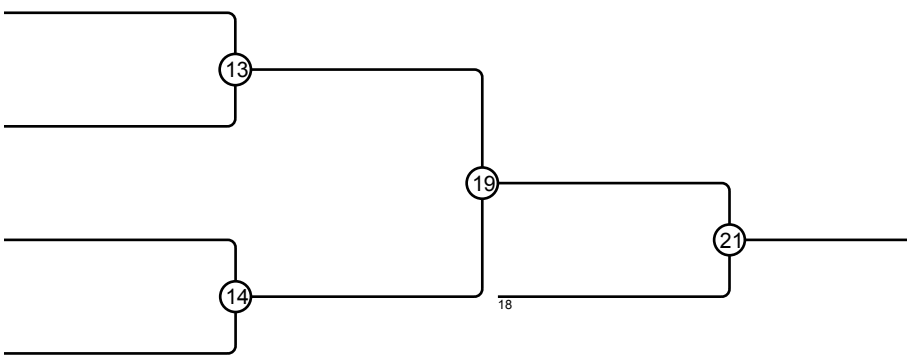
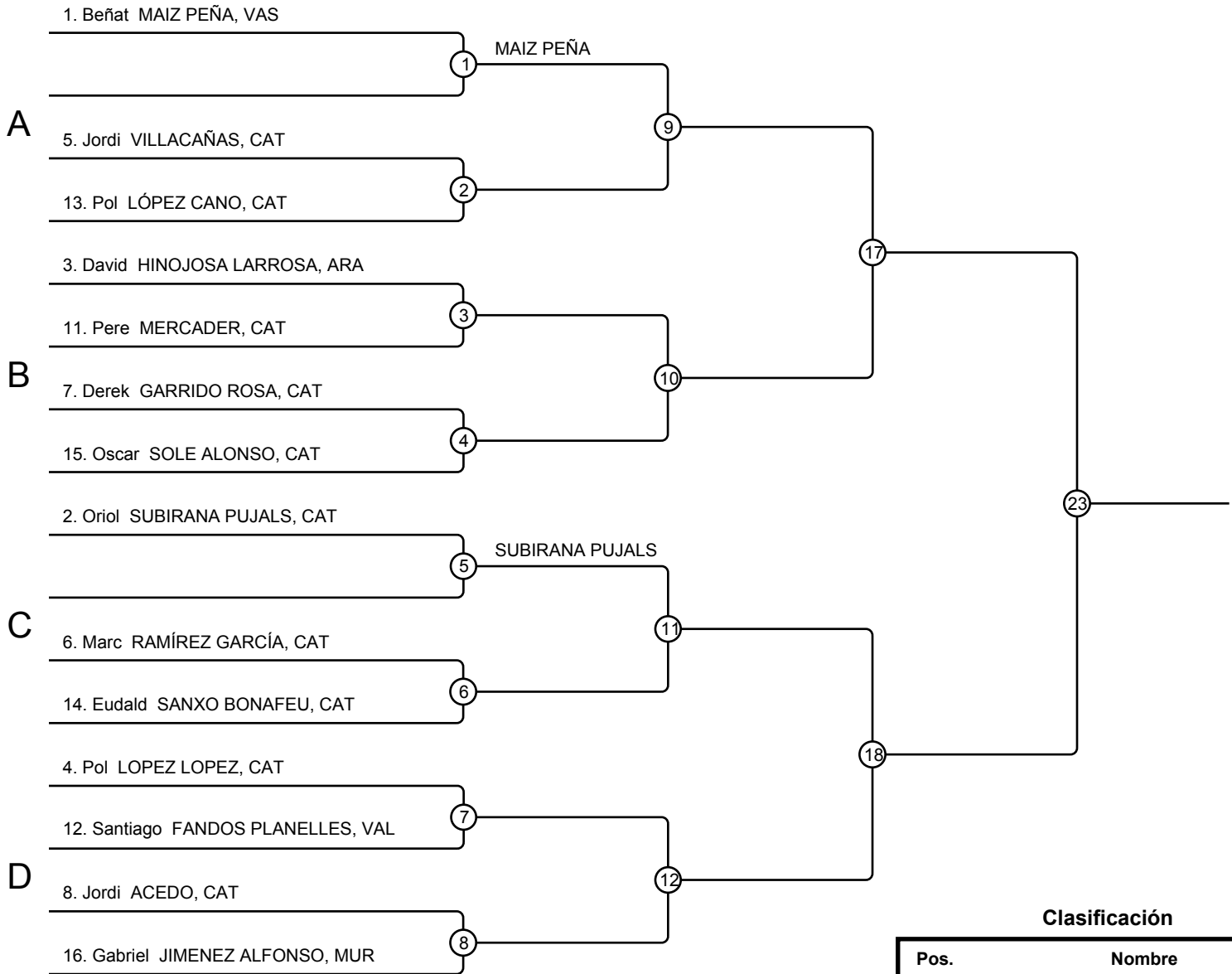

**Clasificación**

| Pos. | Nombre |
|------|--------|
| 1    |        |
| 2    |        |
| 3    |        |
| 3    |        |
| 5    |        |
| 5    |        |
| 7    |        |
| 7    |        |

# III Copa Tortosa SuperCopa Junior

# Jun M -60

Competidores: 19

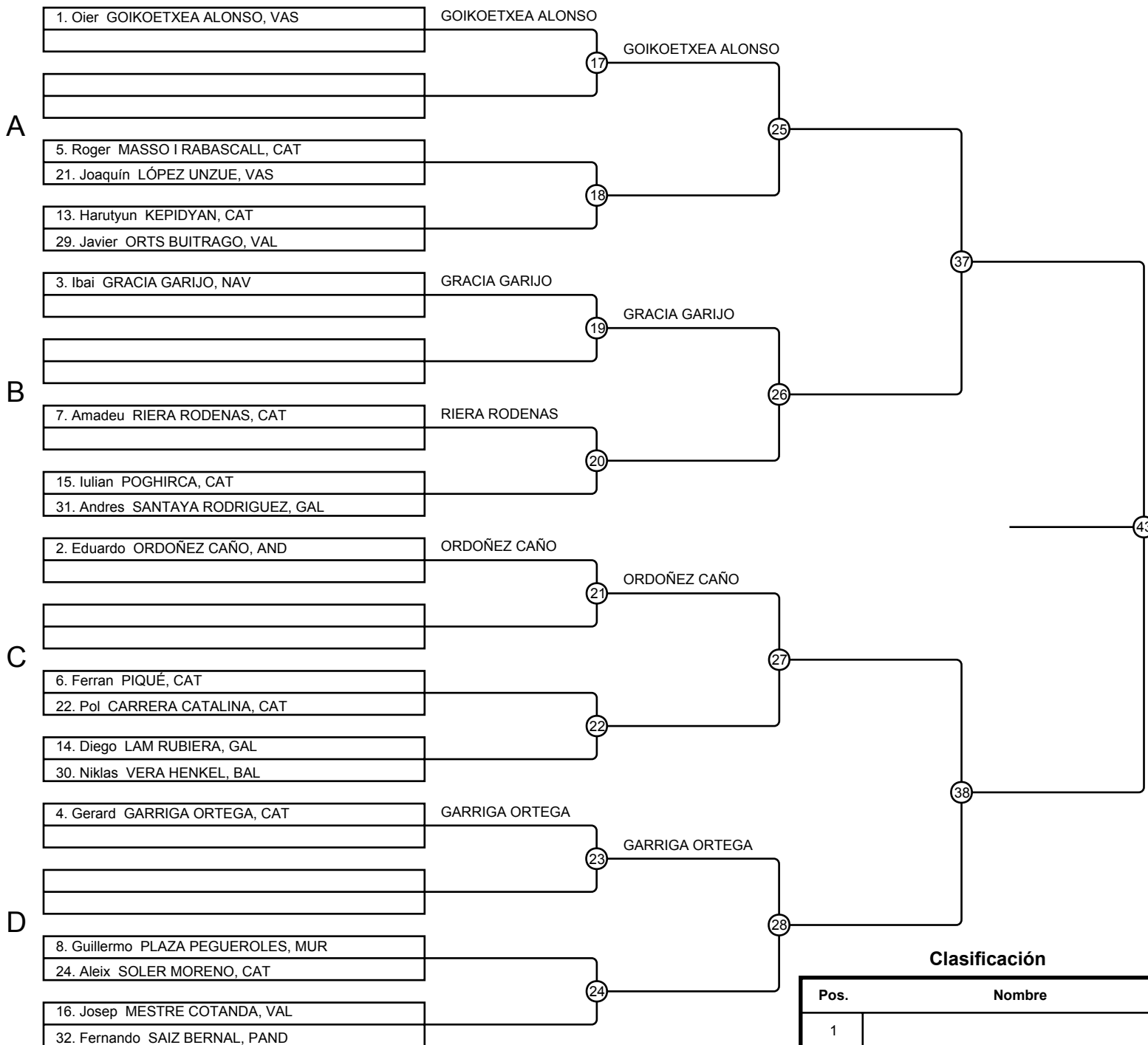

**Clasificación**

| Pos. | Nombre |
|------|--------|
| 1    |        |
| 2    |        |
| 3    |        |
| 3    |        |
| 5    |        |
| 5    |        |
| 7    |        |
| 7    |        |

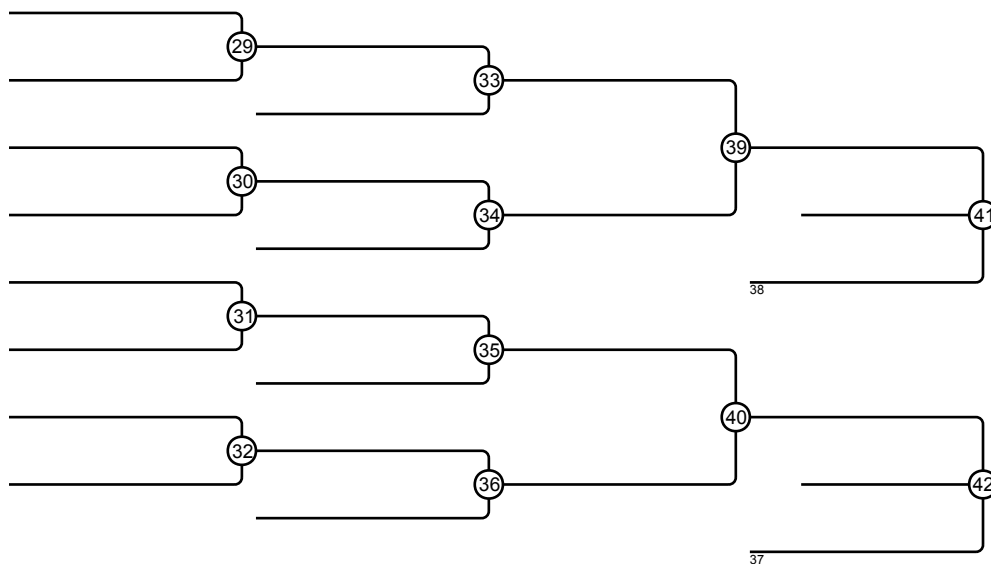

# III Copa Tortosa SuperCopa Junior

Jun M -66 (1/3)

Competidores: 33

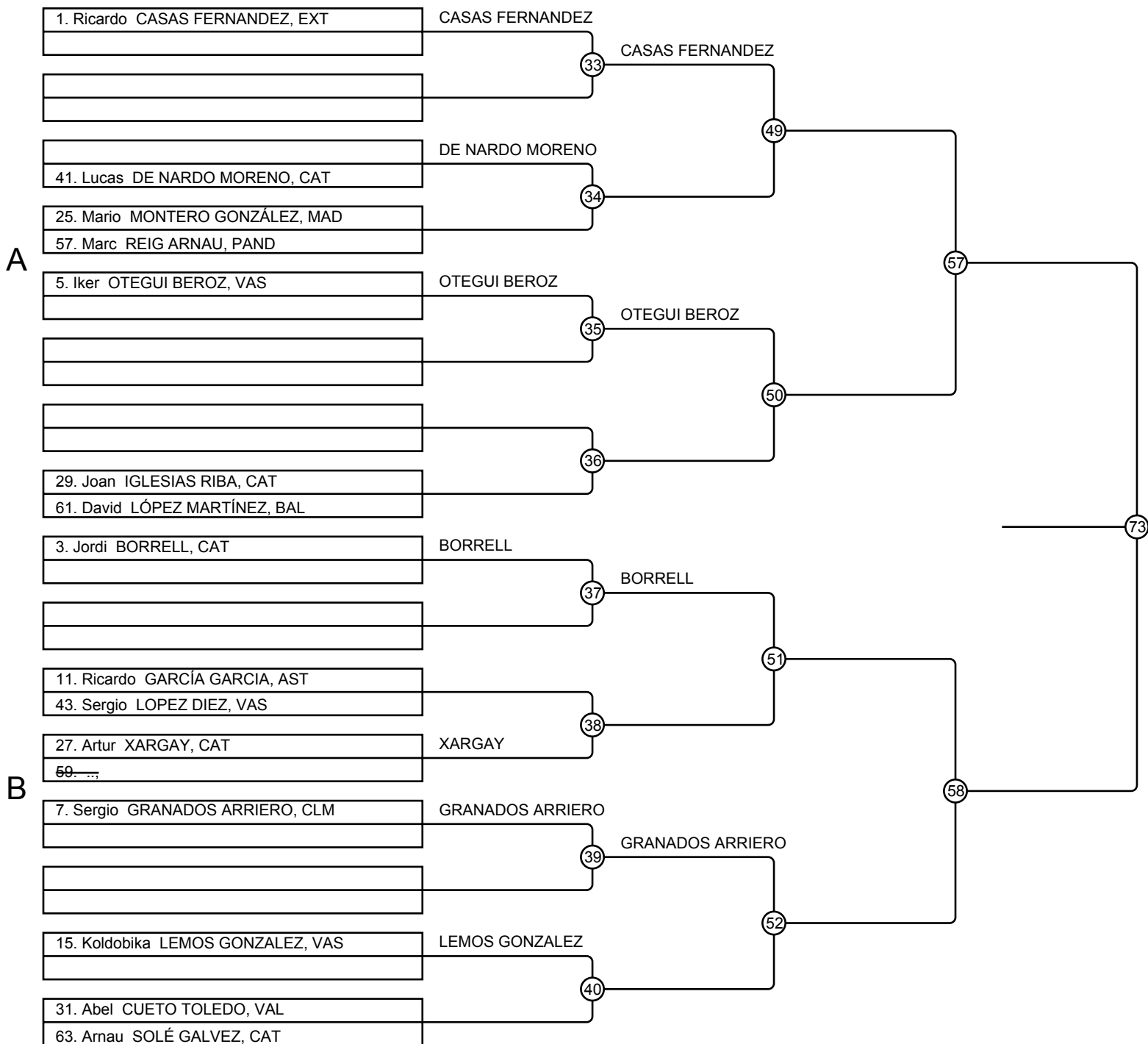



# III Copa Tortosa SuperCopa Junior

Jun M -66 (2/3)

Competidores: 33

C

2. Sergio SANCHEZ LOPEZ, AND  
SANCHEZ LOPEZ

42. Alex SALAS, CAT

26. Jose LUIS SANCHEZ ARNAU, BAL  
58. Raul POBLADOR, ARA

6. Alex DIEZ RODRIGUEZ, VAS

14. Toni TORRA CASAS, CAT  
46. Adrian NIETO CHINARRO, MAD

30. Lucas BALLESTER MIFSUT, VAL  
62. Jon SAENZ DE URTURI UBI, VAS

4. Alberto DIAZ VEGA, MAD

12. Miquel CABRER LLODRÀ, BAL  
44. Juan ALVAREZ CHULIA, VAL

28. Jose LUIS LARRALDE TRUJE, CNT

D

8. Victor HUGO HENRIQUES, GAL

16. Marc CASTELLA, CAT

32. Àngel LUIS PINA TEROL, MUR  
64. Enrique NORAT VILCHEZ, CAT

41. SANCHEZ LOPEZ

42. SALAS

43. DIEZ RODRIGUEZ

44. DIAZ VEGA

45. DIAZ VEGA

46. LUIS LARRALDE TRUJE

47. HUGO HENRIQUES

48. CASTELLA

53. SANCHEZ LOPEZ

54. DIEZ RODRIGUEZ

55. DIAZ VEGA

56. HUGO HENRIQUES

59. SANCHEZ LOPEZ

60. HUGO HENRIQUES

74. SANCHEZ LOPEZ

74. HUGO HENRIQUES

74. DIAZ VEGA

74. SALAS

74. DIEZ RODRIGUEZ

74. LUIS LARRALDE TRUJE

74. CASTELLA

74. HUGO HENRIQUES

74. DIAZ VEGA

74. SALAS

74. DIEZ RODRIGUEZ

74. LUIS LARRALDE TRUJE

74. CASTELLA

74. HUGO HENRIQUES

74. DIAZ VEGA

74. SALAS

74. DIEZ RODRIGUEZ

74. LUIS LARRALDE TRUJE

74. CASTELLA

74. HUGO HENRIQUES

74. DIAZ VEGA

74. SALAS

74. DIEZ RODRIGUEZ

74. LUIS LARRALDE TRUJE

74. CASTELLA

74. HUGO HENRIQUES

74. DIAZ VEGA

74. SALAS

74. DIEZ RODRIGUEZ

74. LUIS LARRALDE TRUJE

74. CASTELLA

74. HUGO HENRIQUES

74. DIAZ VEGA

74. SALAS

74. DIEZ RODRIGUEZ

74. LUIS LARRALDE TRUJE

74. CASTELLA

74. HUGO HENRIQUES

74. DIAZ VEGA

74. SALAS

74. DIEZ RODRIGUEZ

74. LUIS LARRALDE TRUJE

74. CASTELLA

74. HUGO HENRIQUES

74. DIAZ VEGA

74. SALAS

74. DIEZ RODRIGUEZ

74. LUIS LARRALDE TRUJE

74. CASTELLA

74. HUGO HENRIQUES

74. DIAZ VEGA

74. SALAS

74. DIEZ RODRIGUEZ

74. LUIS LARRALDE TRUJE

74. CASTELLA

74. HUGO HENRIQUES

74. DIAZ VEGA

74. SALAS

74. DIEZ RODRIGUEZ

74. LUIS LARRALDE TRUJE

74. CASTELLA

74. HUGO HENRIQUES

74. DIAZ VEGA

74. SALAS

74. DIEZ RODRIGUEZ

74. LUIS LARRALDE TRUJE

74. CASTELLA

74. HUGO HENRIQUES

74. DIAZ VEGA

74. SALAS

74. DIEZ RODRIGUEZ

74. LUIS LARRALDE TRUJE

74. CASTELLA

74. HUGO HENRIQUES

74. DIAZ VEGA

74. SALAS

74. DIEZ RODRIGUEZ

74. LUIS LARRALDE TRUJE

74. CASTELLA

74. HUGO HENRIQUES

74. DIAZ VEGA

74. SALAS

74. DIEZ RODRIGUEZ

74. LUIS LARRALDE TRUJE

74. CASTELLA

74. HUGO HENRIQUES

74. DIAZ VEGA

74. SALAS

74. DIEZ RODRIGUEZ

74. LUIS LARRALDE TRUJE

74. CASTELLA

74. HUGO HENRIQUES

74. DIAZ VEGA

74. SALAS

74. DIEZ RODRIGUEZ

74. LUIS LARRALDE TRUJE

74. CASTELLA

74. HUGO HENRIQUES

74. DIAZ VEGA

74. SALAS

74. DIEZ RODRIGUEZ

74. LUIS LARRALDE TRUJE

74. CASTELLA

74. HUGO HENRIQUES

74. DIAZ VEGA

74. SALAS

74. DIEZ RODRIGUEZ

74. LUIS LARRALDE TRUJE

74. CASTELLA

74. HUGO HENRIQUES

74. DIAZ VEGA

74. SALAS

74. DIEZ RODRIGUEZ

74. LUIS LARRALDE TRUJE

74. CASTELLA

74. HUGO HENRIQUES

74. DIAZ VEGA

74. SALAS

74. DIEZ RODRIGUEZ

74. LUIS LARRALDE TRUJE

74. CASTELLA

74. HUGO HENRIQUES

74. DIAZ VEGA

74. SALAS

74. DIEZ RODRIGUEZ

74. LUIS LARRALDE TRUJE

74. CASTELLA

74. HUGO HENRIQUES

74. DIAZ VEGA

74. SALAS

74. DIEZ RODRIGUEZ

74. LUIS LARRALDE TRUJE

74. CASTELLA

74. HUGO HENRIQUES

74. DIAZ VEGA

74. SALAS

74. DIEZ RODRIGUEZ

74. LUIS LARRALDE TRUJE

74. CASTELLA

74. HUGO HENRIQUES

74. DIAZ VEGA

74. SALAS

74. DIEZ RODRIGUEZ

74. LUIS LARRALDE TRUJE

74. CASTELLA

74. HUGO HENRIQUES

74. DIAZ VEGA

74. SALAS

74. DIEZ RODRIGUEZ

74. LUIS LARRALDE TRUJE

74. CASTELLA

74. HUGO HENRIQUES

74. DIAZ VEGA

74. SALAS

74. DIEZ RODRIGUEZ

74. LUIS LARRALDE TRUJE

74. CASTELLA

74. HUGO HENRIQUES

74. DIAZ VEGA

74. SALAS

74. DIEZ RODRIGUEZ

74. LUIS LARRALDE TRUJE

74. CASTELLA

74. HUGO HENRIQUES

74. DIAZ VEGA

74. SALAS

74. DIEZ RODRIGUEZ

74. LUIS LARRALDE TRUJE

74. CASTELLA

74. HUGO HENRIQUES

74. DIAZ VEGA

74. SALAS

74. DIEZ RODRIGUEZ

74. LUIS LARRALDE TRUJE

74. CASTELLA

74. HUGO HENRIQUES

74. DIAZ VEGA

74. SALAS

74. DIEZ RODRIGUEZ

74. LUIS LARRALDE TRUJE

74. CASTELLA

74. HUGO HENRIQUES

74. DIAZ VEGA

74. SALAS

74. DIEZ RODRIGUEZ

74. LUIS LARRALDE TRUJE

74. CASTELLA

74. HUGO HENRIQUES

74. DIAZ VEGA

74. SALAS

74. DIEZ RODRIGUEZ

74. LUIS LARRALDE TRUJE

74. CASTELLA

74. HUGO HENRIQUES

74. DIAZ VEGA

74. SALAS

74. DIEZ RODRIGUEZ

74. LUIS LARRALDE TRUJE

74. CASTELLA

74. HUGO HENRIQUES

74. DIAZ VEGA

74. SALAS

74. DIEZ RODRIGUEZ

74. LUIS LARRALDE TRUJE

74. CASTELLA

74. HUGO HENRIQUES

74. DIAZ VEGA

74. SALAS

74. DIEZ RODRIGUEZ

74. LUIS LARRALDE TRUJE

74. CASTELLA

74. HUGO HENRIQUES

74. DIAZ VEGA

74. SALAS

74. DIEZ RODRIGUEZ

74. LUIS LARRALDE TRUJE

74. CASTELLA

74. HUGO HENRIQUES

74. DIAZ VEGA

74. SALAS

74. DIEZ RODRIGUEZ

74. LUIS LARRALDE TRUJE

74. CASTELLA

74. HUGO HENRIQUES

74. DIAZ VEGA

74. SALAS

74. DIEZ RODRIGUEZ

74. LUIS LARRALDE TRUJE

74. CASTELLA

74. HUGO HENRIQUES

74. DIAZ VEGA

74. SALAS

74. DIEZ RODRIGUEZ

74. LUIS LARRALDE TRUJE

74. CASTELLA

# III Copa Tortosa SuperCopa Junior

Jun M -66 (3/3)

Competidores: 33

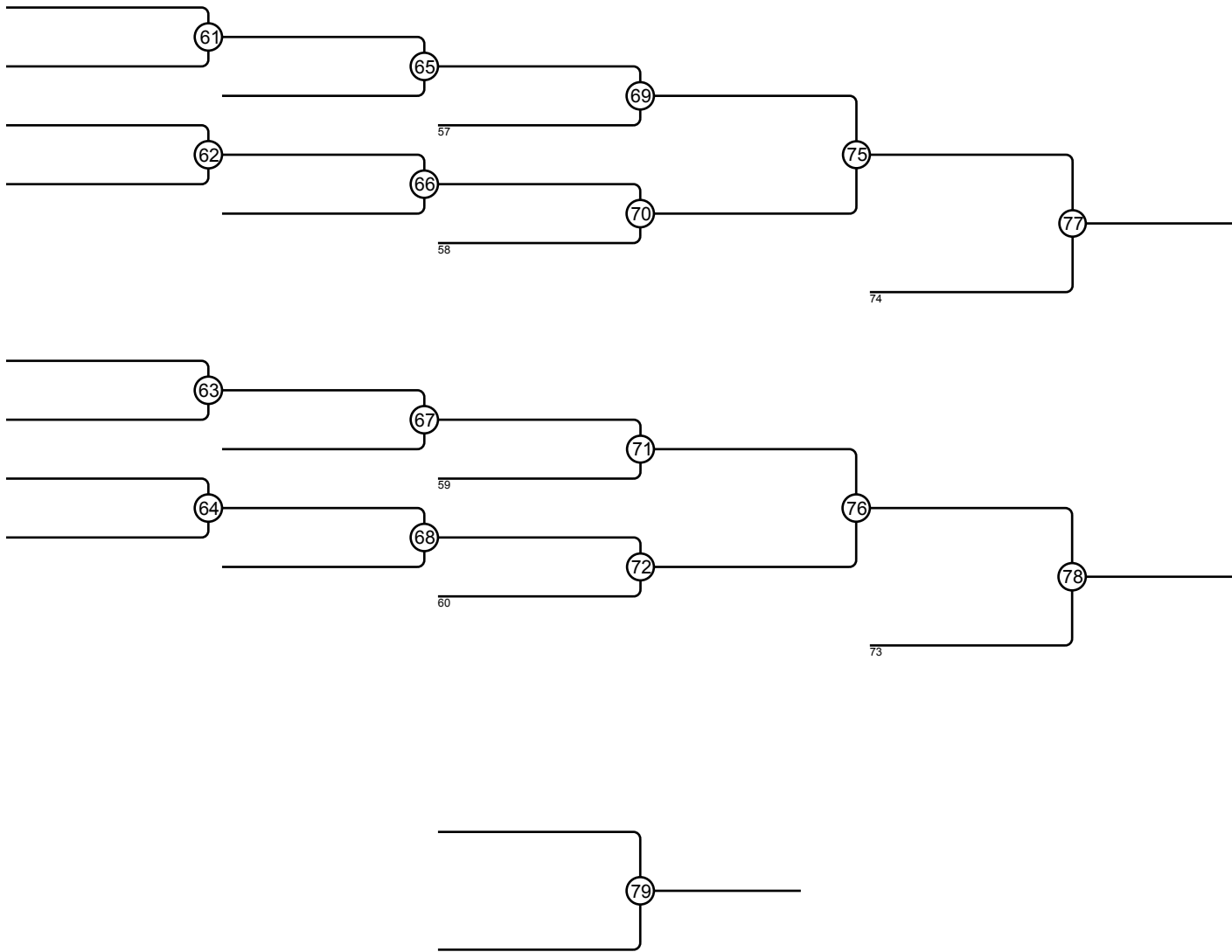

## Clasificación

| Pos. | Nombre |
|------|--------|
| 1    |        |
| 2    |        |
| 3    |        |
| 3    |        |
| 5    |        |
| 5    |        |
| 7    |        |
| 7    |        |

# III Copa Tortosa SuperCopa Junior

Jun M -73 (1/3)

Competidores: 33

A

1. Jose JULIAN RAMIREZ SANC, MAD

JULIAN RAMIREZ SANC

[Empty box]

33 JULIAN RAMIREZ SANC

9. Sergio MALO ORTEGA, CAT

41. Juan ANTONIO VALERO COTI, CLM

ANDREU MOSEGUI

34

57. Martí ANDREU MOSEGUI, CAT

5. Marc VALLS, CAT

VALLS

[Empty box]

35 VALLS

13. Daniel SHORT, CAT

45. Mael BAIXAULI ARSON, VAL

36

29. Jordi SOLE ALONSO, CAT

61. Sergio GONZÁLEZ RAMOS, EXT

3. Luis MARTINEZ, VAL

MARTINEZ

[Empty box]

37 MARTINEZ

11. Ignacio ALVAREZ, CAT

43. Iker BLANCO BRAVO, CAT

38

[Empty box]

LOPEZ

59. Frank LOPEZ, CAT

7. Javier CABELLO ORTIZ, CAT

CABELLO ORTIZ

[Empty box]

39 CABELLO ORTIZ

46. ....

47. Aritz GARCÍA GARMENDÍA, VAS

GARCÍA GARMENDÍA

40

31. Eduard XARGAY, CAT

XARGAY

B

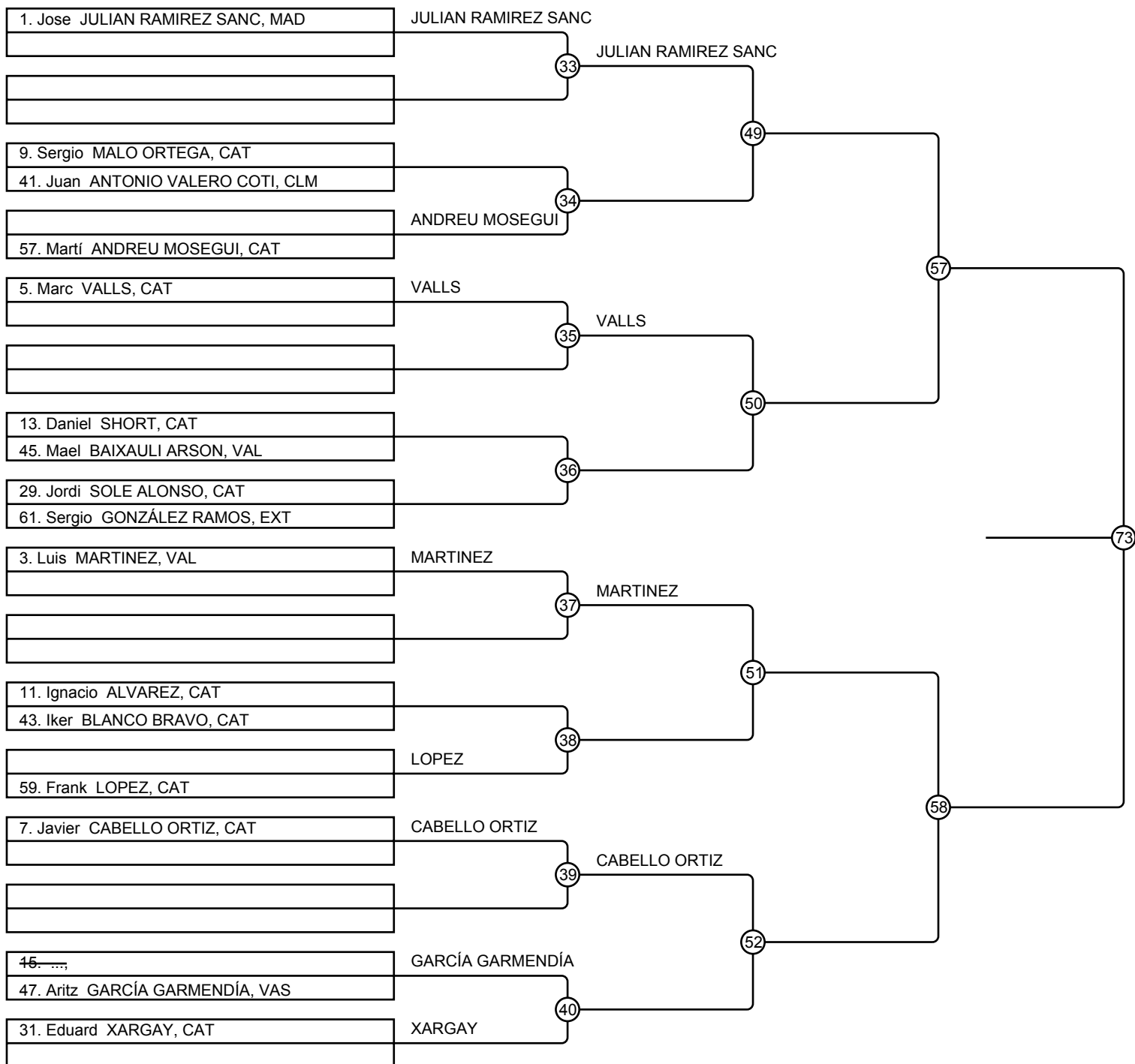

# III Copa Tortosa SuperCopa Junior

Jun M -73 (2/3)

Competidores: 33

C

|                                  |                   |
|----------------------------------|-------------------|
| 2. Carlos SOTILLO GOMEZ, MAD     | SOTILLO GOMEZ     |
|                                  |                   |
| 10. Yeray FERRAGUT VALENCIA, CAT | FERRAGUT VALENCIA |
| 26. Miqui POLO, CAT              |                   |
| 58. Roger FONTANET CLARET, CAT   |                   |

|                                    |                   |
|------------------------------------|-------------------|
| 6. Salvador GOMARIZ MORENILLA, MUR | GOMARIZ MORENILLA |
|                                    |                   |
|                                    |                   |
|                                    |                   |

|                                 |  |
|---------------------------------|--|
| 14. Pau FERRER, CAT             |  |
| 46. Nshan KEPIDYAN, CAT         |  |
| 30. Sergio BAYARRI VAZQUEZ, VAL |  |
| 62. Nika CHAVETADZE, CAT        |  |

|                          |        |
|--------------------------|--------|
| 4. Cristofol DAUDEN, CAT | DAUDEN |
|                          |        |
|                          |        |
|                          |        |

|                               |                     |
|-------------------------------|---------------------|
|                               | GABRIEL PANADERO PA |
| 44. Luis GABRIEL PANADERO PA, |                     |
| 28. Eduardo LOPEZ DIAZ, NAV   | LOPEZ DIAZ          |
|                               |                     |

D

|                                |                 |
|--------------------------------|-----------------|
| 8. Javier RAMOS BALLESTER, VAL | RAMOS BALLESTER |
|                                |                 |
|                                |                 |
|                                |                 |

|                                    |         |
|------------------------------------|---------|
| 16. Gorka SALGADO, CAT             | SALGADO |
|                                    |         |
| 32. Daniel ROMERO GUTIERREZ, CAT   |         |
| 64. Ander CUETO LOPEZ DE GUER, VAS |         |

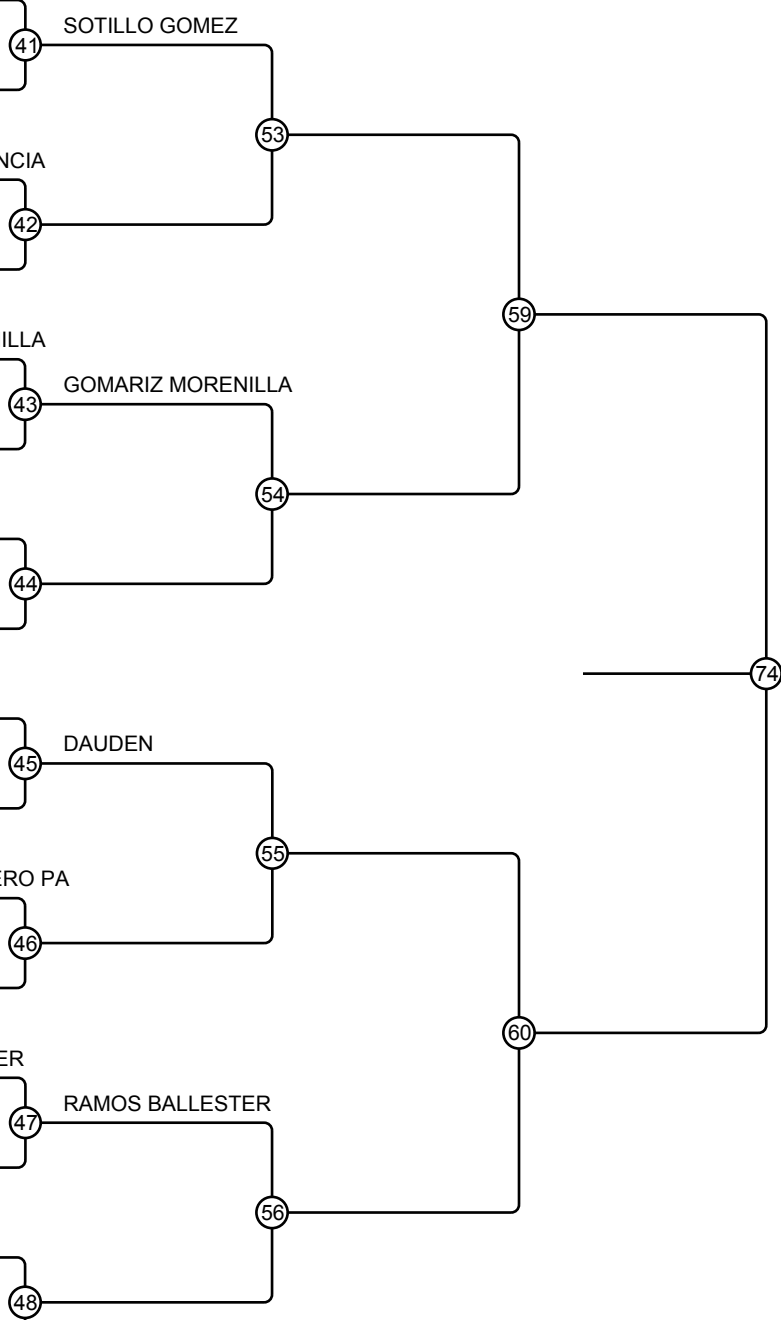

# III Copa Tortosa SuperCopa Junior

Jun M -73 (3/3)

Competidores: 33

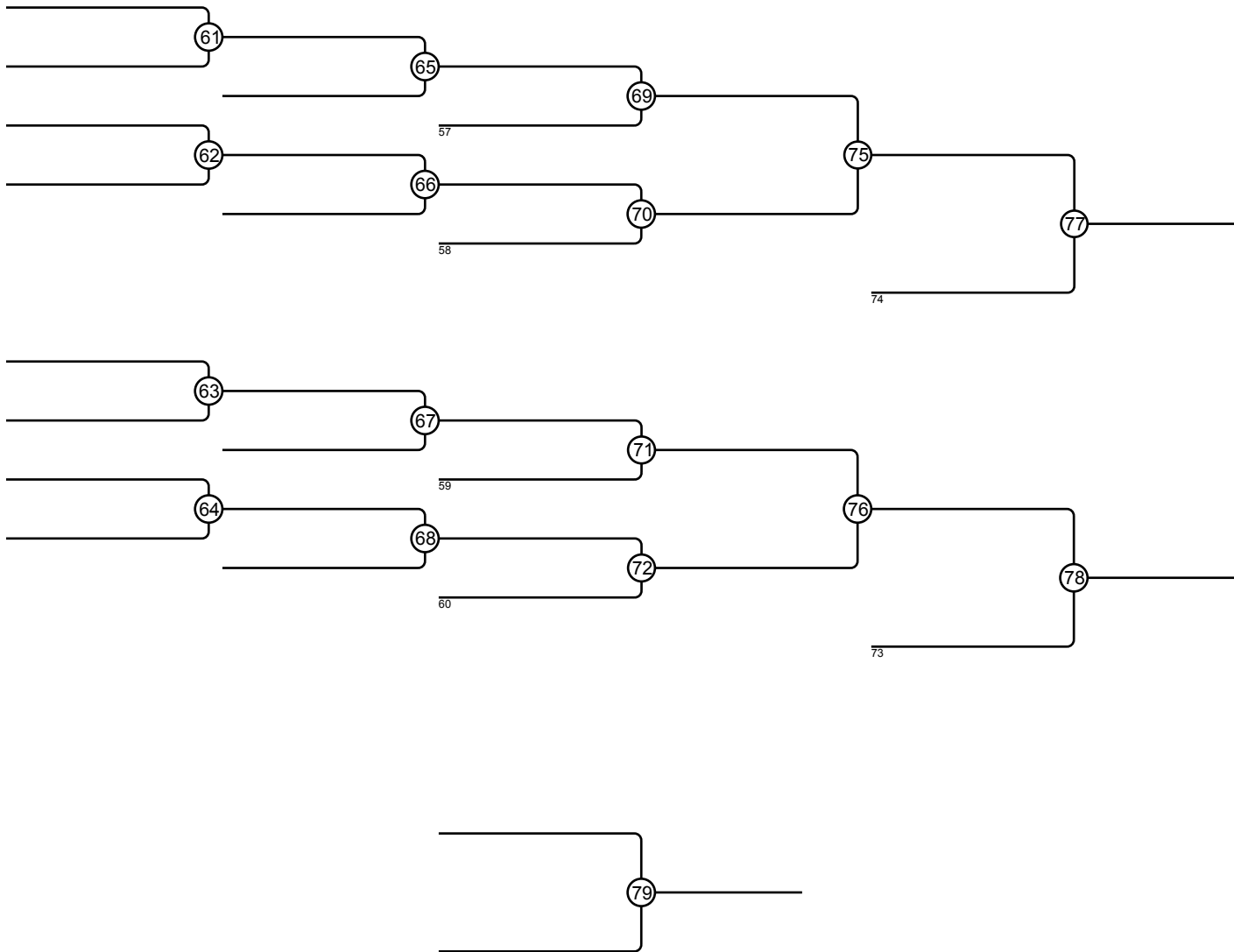

## Clasificación

| Pos. | Nombre |
|------|--------|
| 1    |        |
| 2    |        |
| 3    |        |
| 3    |        |
| 5    |        |
| 5    |        |
| 7    |        |
| 7    |        |

# III Copa Tortosa SuperCopa Junior

## Jun M -81

Competidores: 19

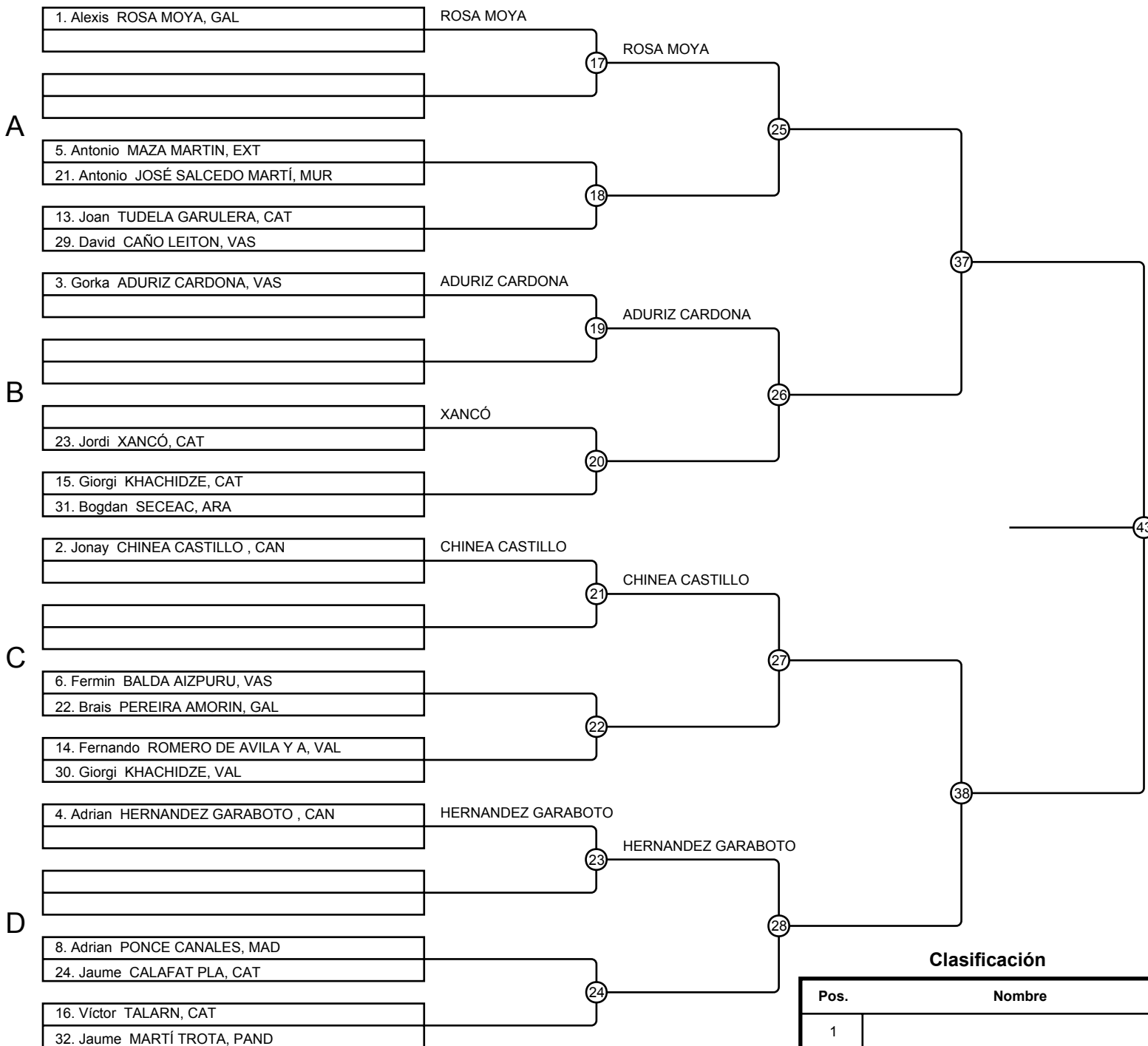

**Clasificación**

| Pos. | Nombre |
|------|--------|
| 1    |        |
| 2    |        |
| 3    |        |
| 3    |        |
| 5    |        |
| 5    |        |
| 7    |        |
| 7    |        |

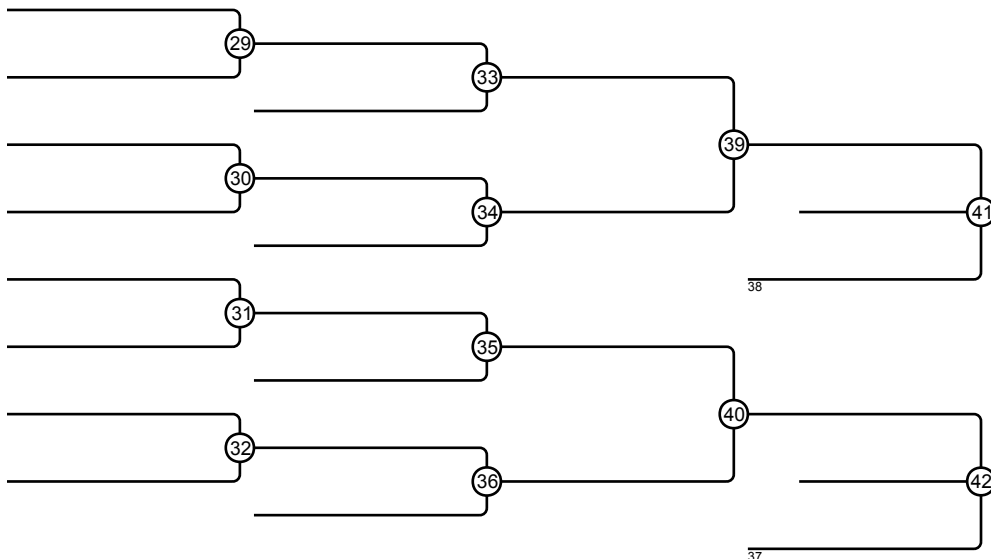

# III Copa Tortosa SuperCopa Junior

Jun M -90

Competidores: 9

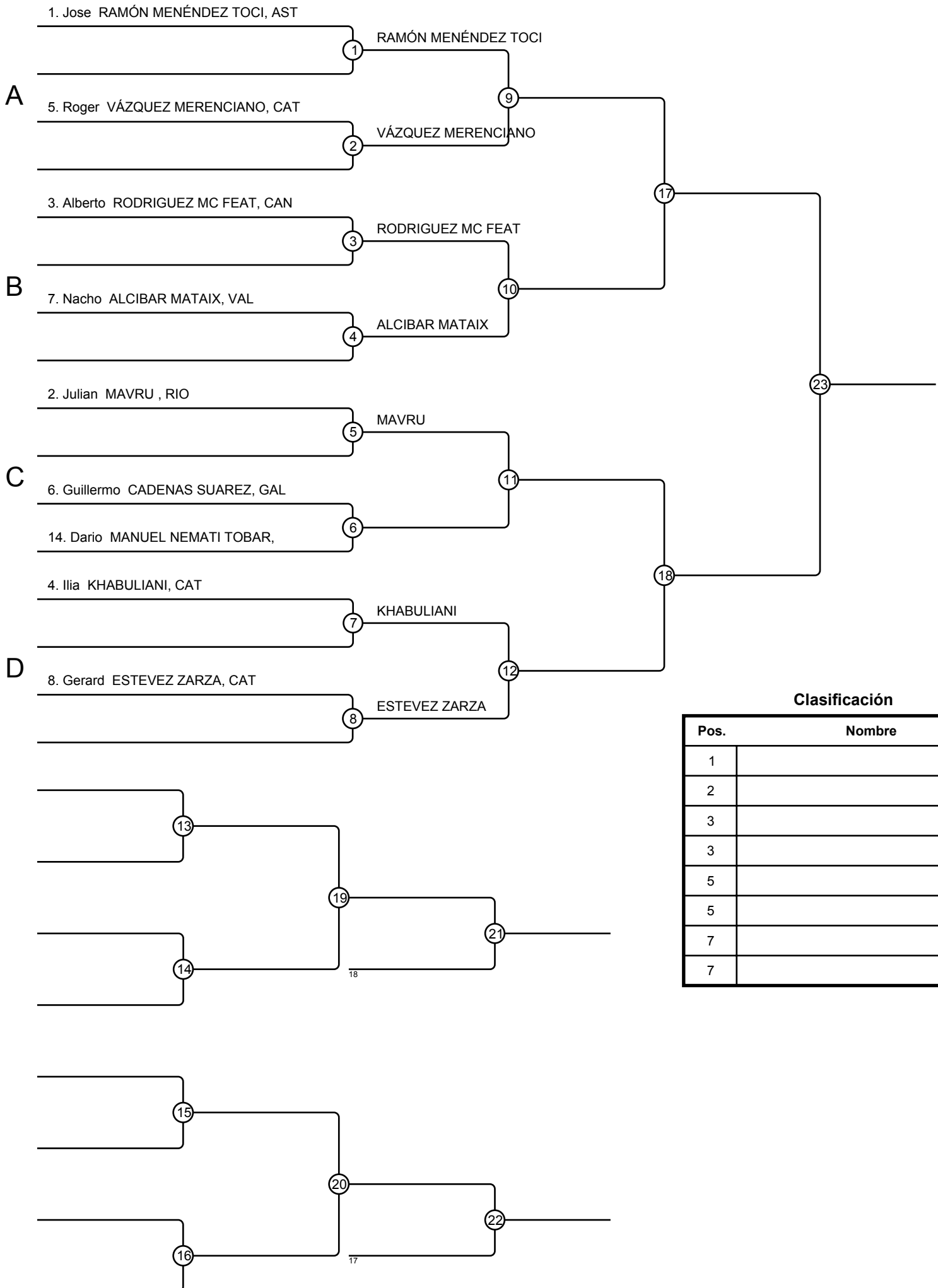

**Clasificación**

| Pos. | Nombre |
|------|--------|
| 1    |        |
| 2    |        |
| 3    |        |
| 3    |        |
| 5    |        |
| 5    |        |
| 7    |        |
| 7    |        |

# III Copa Tortosa SuperCopa Junior

## Jun M -100

Competidores: 7

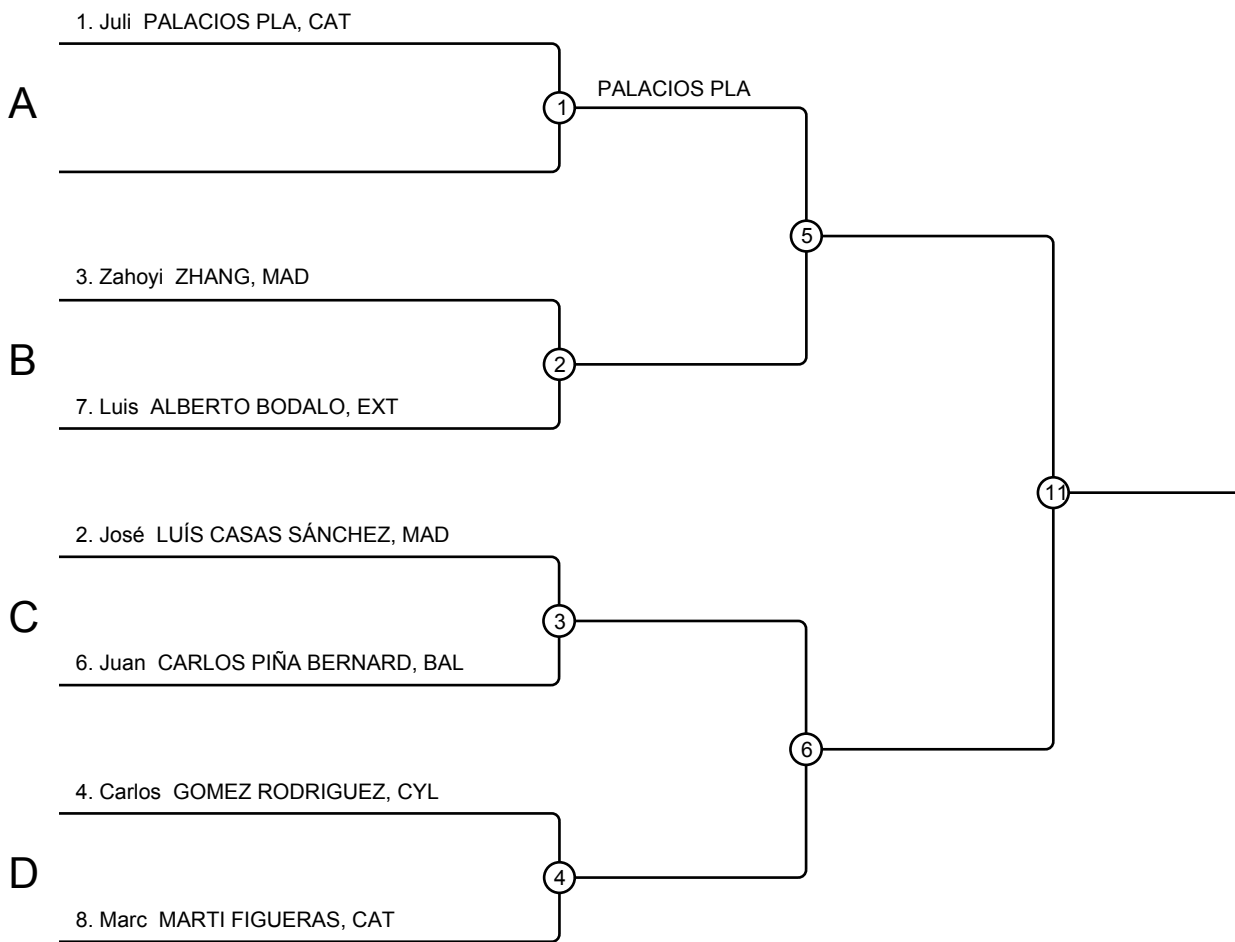

**Clasificación**

| Pos. | Nombre |
|------|--------|
| 1    |        |
| 2    |        |
| 3    |        |
| 3    |        |
| 5    |        |
| 5    |        |
| 7    |        |
| 7    |        |

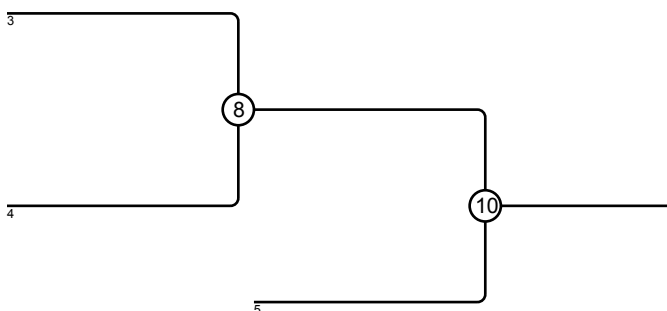
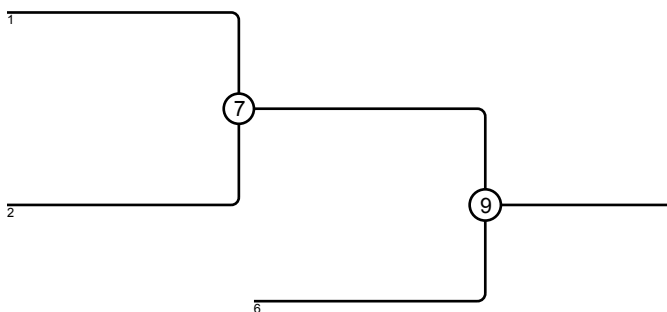



# III Copa Tortosa SuperCopa Junior

# Jun M +100

Competidores: 4

## Competidores

| Nº | Nombre                   | Club | 1 | 2 | 3 | 4 | Victs. | Pts. | Pos. |
|----|--------------------------|------|---|---|---|---|--------|------|------|
| 1  | Juan CARLOS PIÑA BERNARD | BAL  |   |   |   |   |        |      |      |
| 2  | David SANDSTROM DAPARTE  | RIO  |   |   |   |   |        |      |      |
| 3  | Irinel VASILE CHELARU    | VAL  |   |   |   |   |        |      |      |
| 4  | Jose MIGUEL CASTILLO PEÑ | EXT  |   |   |   |   |        |      |      |

## Combates

| Comb. | Blanco                   |   |   | Azul                     | Resultado | Tiempo |
|-------|--------------------------|---|---|--------------------------|-----------|--------|
| 1     | Juan CARLOS PIÑA BERNARD | 1 | 2 | David SANDSTROM DAPARTE  |           |        |
| 2     | Irinel VASILE CHELARU    | 3 | 4 | Jose MIGUEL CASTILLO PEÑ |           |        |
| 3     | Juan CARLOS PIÑA BERNARD | 1 | 3 | Irinel VASILE CHELARU    |           |        |
| 4     | David SANDSTROM DAPARTE  | 2 | 4 | Jose MIGUEL CASTILLO PEÑ |           |        |
| 5     | Juan CARLOS PIÑA BERNARD | 1 | 4 | Jose MIGUEL CASTILLO PEÑ |           |        |
| 6     | David SANDSTROM DAPARTE  | 2 | 3 | Irinel VASILE CHELARU    |           |        |

## Clasificación

| Pos. | Nombre |
|------|--------|
| 1    |        |
| 2    |        |
| 3    |        |
| 3    |        |