



FEDERACIÓ CATALANA DE JUDO

AIKIDO - DIP - JIU JITSU - KENDO
NIHON TAI JITSU - WU SHU

RESULTATS FASE SECTOR CAMPIONAT D'ESPANYA S21

CEM OLIMPICS - BARCELONA - 21-2-2015

CATEGORIA MASCULINA

M-55 (9)

1. AMADEU RIERA	CAT
2. BORJA BENEJAN	BAL
3. GABRIEL JIMENEZ	MUR
4. GONZALO LOPEZ	VAL
5. ROGER MASSÓ	CAT
5. JOSEP MESTRE	VAL

M-60 (10)

1. DAVID GARCIA	CAT
2. GERARD GARRIGA	CAT
3. MARC CASTELLÀ	CAT
4. TONI TORRA	CAT
5. GUILLERMO PLAZA	MUR
5. MIQUEL CABRER	BAL

M-66 (10)

1. JAVIER CABELLO	CAT
2. JORDI BORRELL	CAT
3. RAUL MOLINA	VAL
4. PABLO GUERRERO	MUR
5. JORGE CABO	VAL
5. RAUL ALVAREZ	BAL

M-73 (10)

1. ALEX MARIN	VAL
2. LUIS MARTINEZ	VAL
3. ADRIAN OLIVER	VAL
4. DIEGO DEL CASTILLO	CAT
5. PABLO GONZALBO	VAL
5. SALVADOR GOMARIZ	MUR

M-81 (7)

1. JORDI XANCÓ	CAT
2. JESÚS FUENTE	CAT
3. FERNANDO ROMERO DE AVILA	VAL
4. EDGAR IGLESIAS	CAT
5. ANAEL RUIZ	CAT
5. FRANCISCO JOSE SALA	BAL



FEDERACIÓ CATALANA DE JUDO

AIKIDO - DIP - JIU JITSU - KENDO
NIHON TAI JITSU - WU SHU

M-90 (9)

- | | |
|-------------------|-----|
| 1. VÍCTOR BARRERO | CAT |
| 2. DAVID LAZARO | BAL |
| 3. NACHO ALCIBAR | VAL |
| 4. GERARD ESTÉVEZ | CAT |
| 5. DANIEL GUILLÉN | CAT |
| 5. OSCAR GÒMEZ | CAT |

M-100 (4)

- | | |
|-----------------------|-----|
| 1. SANDRO OTARASHVILI | VAL |
| 2. JORGE GALLEGO | CAT |
| 3. MARC MARTÍ | CAT |

M+100 (2)

- | | |
|---------------------|-----|
| 1. JUAN CARLOS PIÑA | BAL |
| 2. ALEJANDRO DIAZ | MUR |



FEDERACIÓ CATALANA DE JUDO

AIKIDO - DIP - JIU JITSU - KENDO
NIHON TAI JITSU - WU SHU

RESULTATS FASE SECTOR CAMPIONAT D'ESPANYA S21

CEM OLIMPICS - BARCELONA - 21-2-2015

CATEGORIA FEMENINA

F-44 (3)

- | | |
|---------------------|-----|
| 1. MIREIA RODRIGUEZ | VAL |
| 2. MARINA GARRIGA | CAT |
| 3. LAURA DE LA CRUZ | BAL |

F-48 (4)

- | | |
|-----------------------|-----|
| 1. CAROL ZAMBUDIO | CAT |
| 2. MARIA OLIVER | BAL |
| 3. CRISTINA BALLESTER | VAL |

F-52 (6)

- | | |
|-------------------|-----|
| 1. IRENE ASENSIO | VAL |
| 2. MÍRIAM ROSADO | CAT |
| 3. ELENA GASSULL | CAT |
| 4. DIANA JIMENEZ | BAL |
| 5. ARIADNA ESCOLÀ | CAT |
| 5. PAULA MARTINEZ | VAL |

F-57 (11)

- | | |
|--------------------|-----|
| 1. ANA PEREZ | VAL |
| 2. NEUS POU | VAL |
| 3. PATRICIA TORRES | CAT |
| 4. GEMMA BRUGUERA | CAT |
| 5. MARIA ORTIZ | VAL |
| 5. TANIA TEIXIDOR | BAL |

F-63 (10)

- | | |
|-----------------------|-----|
| 1. MAITANE HERRERO | VAL |
| 2. MARTA ORTIZ | VAL |
| 3. JAZMÍN LEAH ARJONA | CAT |
| 4. VLADA KOPNAYAYEVA | MUR |
| 5. LAIA RIBERA | CAT |
| 5. CLARA GUERRERO | VAL |



FEDERACIÓ CATALANA DE JUDO

AIKIDO - DIP - JIU JITSU - KENDO
NIHON TAI JITSU - WU SHU

F-70 (9)

- | | |
|-------------------|-----|
| 1. CRISTINA PEREZ | MUR |
| 2. ALBA GUTIERREZ | VAL |
| 3. MARIA SARLE | CAT |
| 4. MIRIAM SILVA | MUR |
| 5. PLACIDA GARCIA | VAL |
| 5. MÒNICA ESPAÑOL | CAT |

F-78 (1)

- | | |
|----------------|-----|
| 1. LORENA LERA | MUR |
|----------------|-----|

F+78 (3)

- | | |
|-------------------------|-----|
| 1. MARTA ANTÓN | CAT |
| 2. INMACULADA GARRIGUES | VAL |
| 3. EVA FERNANDEZ | VAL |

Sector Este C. de España Junior 2015 21-2-2015 F-44

Competidores: 3

Competidores

Nº	Nombre	Club	1	2	3	Victs.	Pts.	Pos.
1	MARINA GARRIGA	CAT			10	1	10	2
2	MIREIA RODRIGUEZ	VAL	10		10	2	20	1
3	LAURA DE LA CRUZ	BAL				0	0	3

Combates

Comb.	Blanco			Azul	Resultado	Tiempo
1	MARINA GARRIGA	1	2	MIREIA RODRIGUEZ	0 - 10	0:58
2	MARINA GARRIGA	1	3	LAURA DE LA CRUZ	10 - 0	1:29
3	MIREIA RODRIGUEZ	2	3	LAURA DE LA CRUZ	10 - 0	0:14

Clasificación

Pos.	Nombre
1	MIREIA RODRIGUEZ, VAL
2	MARINA GARRIGA, CAT
3	LAURA DE LA CRUZ, BAL

Sector Este C. de España Junior 2015 21-2-2015 F-48

Competidores: 4

Competidores

Nº	Nombre	Club	1	2	3	4	Victs.	Pts.	Pos.
1	PAULA ROSET	CAT					0	0	4
2	CAROL ZAMBUDIO	CAT	10		5	1	3	16	1
3	MARIA OLIVER	BAL	10			10	2	20	2
4	CRISTINA BALLESTER	VAL	10				1	10	3

Combates

Comb.	Blanco			Azul	Resultado	Tiempo
1	PAULA ROSET	1	2	CAROL ZAMBUDIO	0 - 10	1:36
2	MARIA OLIVER	3	4	CRISTINA BALLESTER	10 - 0	2:03
3	PAULA ROSET	1	3	MARIA OLIVER	0 - 10	3:18
4	CAROL ZAMBUDIO	2	4	CRISTINA BALLESTER	1 - 0	4:00
5	PAULA ROSET	1	4	CRISTINA BALLESTER	0 - 10	2:10
6	CAROL ZAMBUDIO	2	3	MARIA OLIVER	5 - 0	4:00

Clasificación

Pos.	Nombre
1	CAROL ZAMBUDIO, CAT
2	MARIA OLIVER, BAL
3	CRISTINA BALLESTER, VAL
4	PAULA ROSET, CAT

Sector Este C. de España Junior 2015 21-2-2015 F-52

Competidores: 6

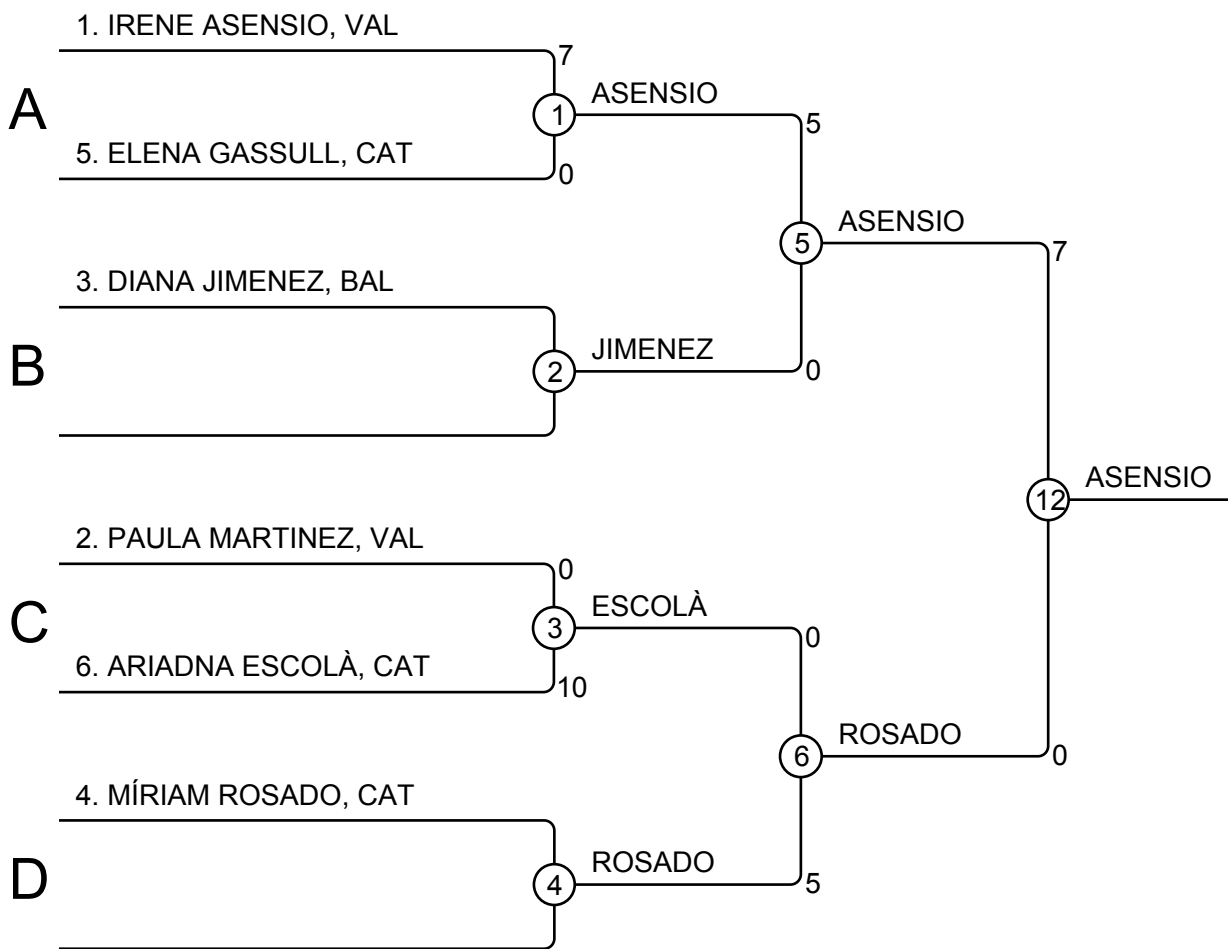

Clasificación

Pos.	Nombre
1	IRENE ASENSIO, VAL
2	MÍRIAM ROSADO, CAT
3	ELENA GASSULL, CAT
4	DIANA JIMENEZ, BAL
5	ARIADNA ESCOLÀ, CAT
5	PAULA MARTINEZ, VAL

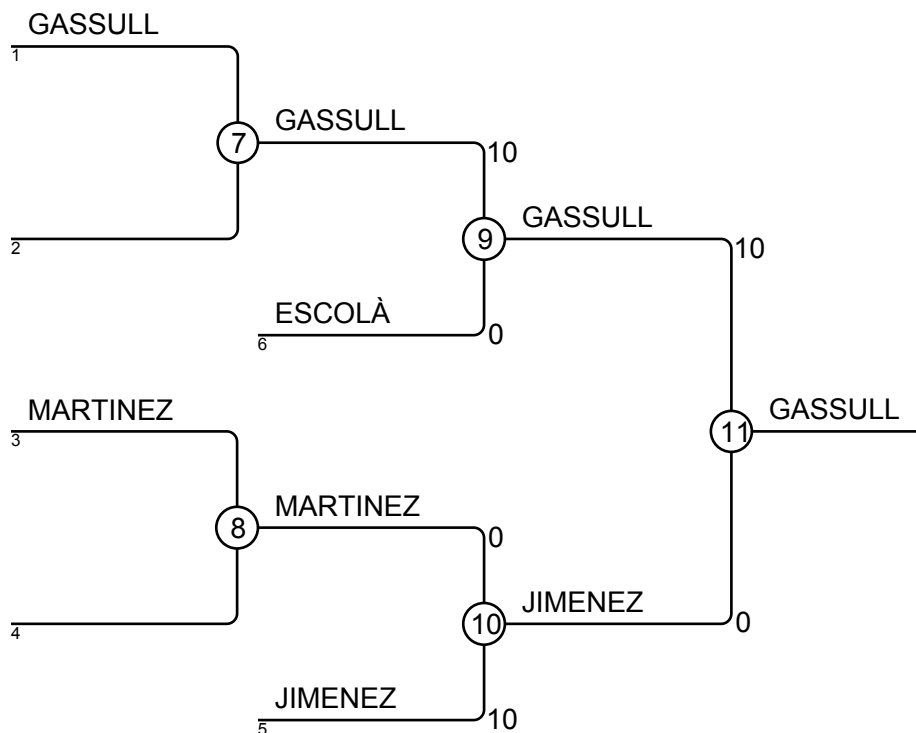

Sector Este C. de España Junior 2015 21-2-2015 F-57

Competidores: 11

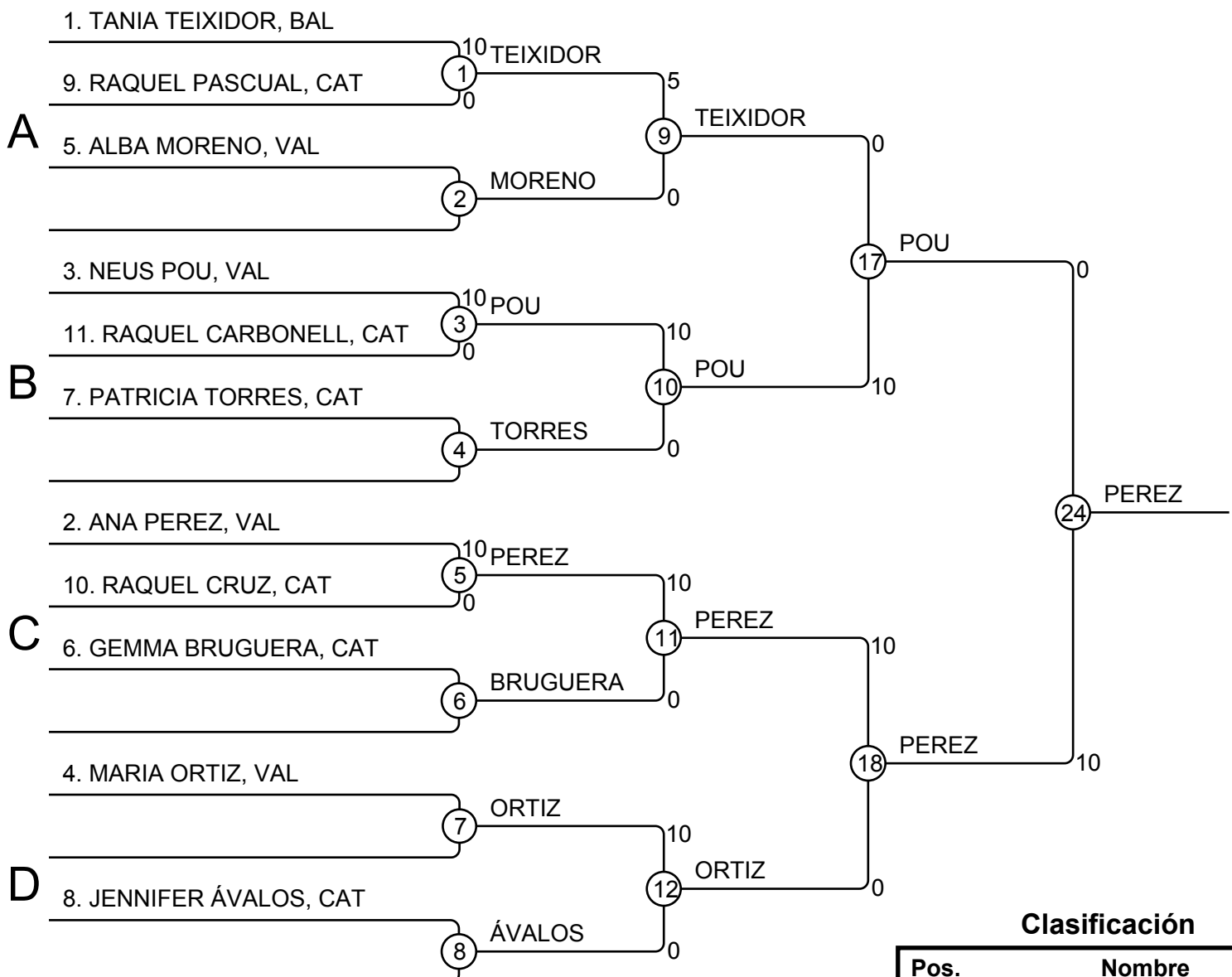

Clasificación

Pos.	Nombre
1	ANA PEREZ, VAL
2	NEUS POU, VAL
3	PATRICIA TORRES, CAT
4	GEMMA BRUGUERA, CAT
5	MARIA ORTIZ, VAL
5	TANIA TEIXIDOR, BAL

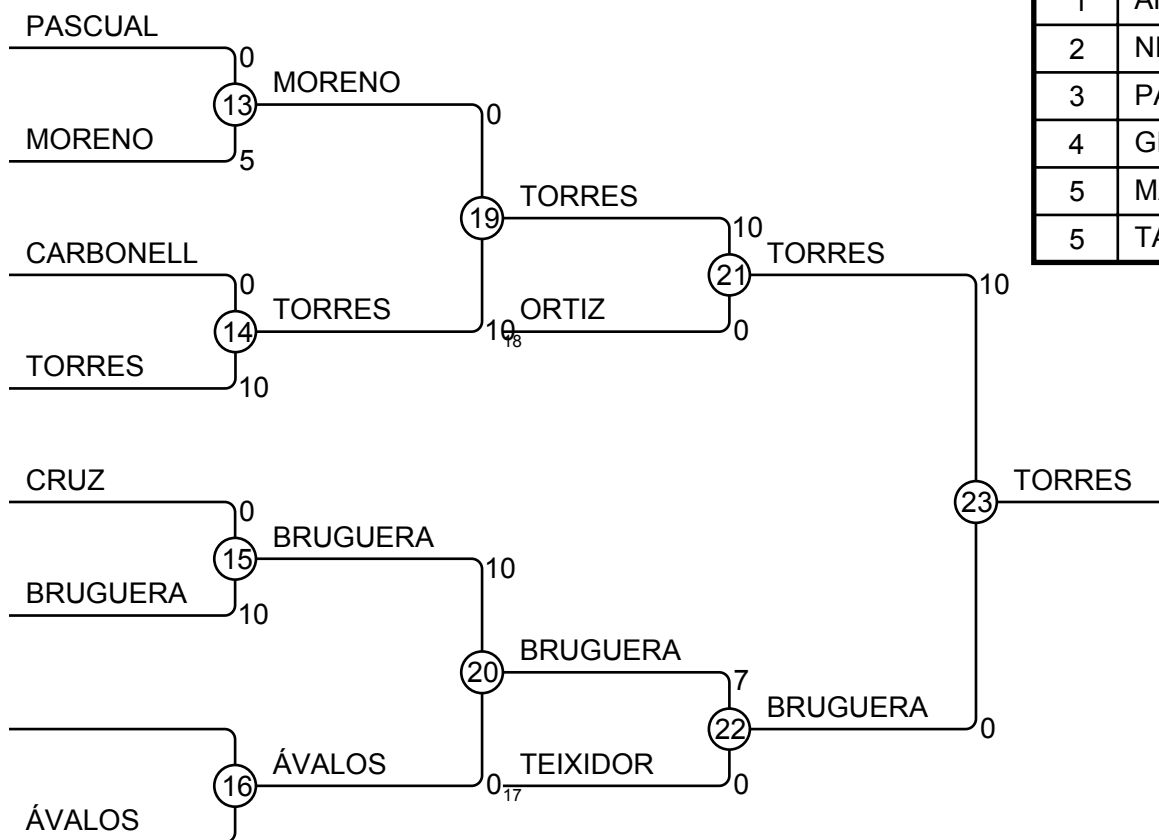

Sector Este C. de España Junior 2015 21-2-2015 F-63

Competidores: 10

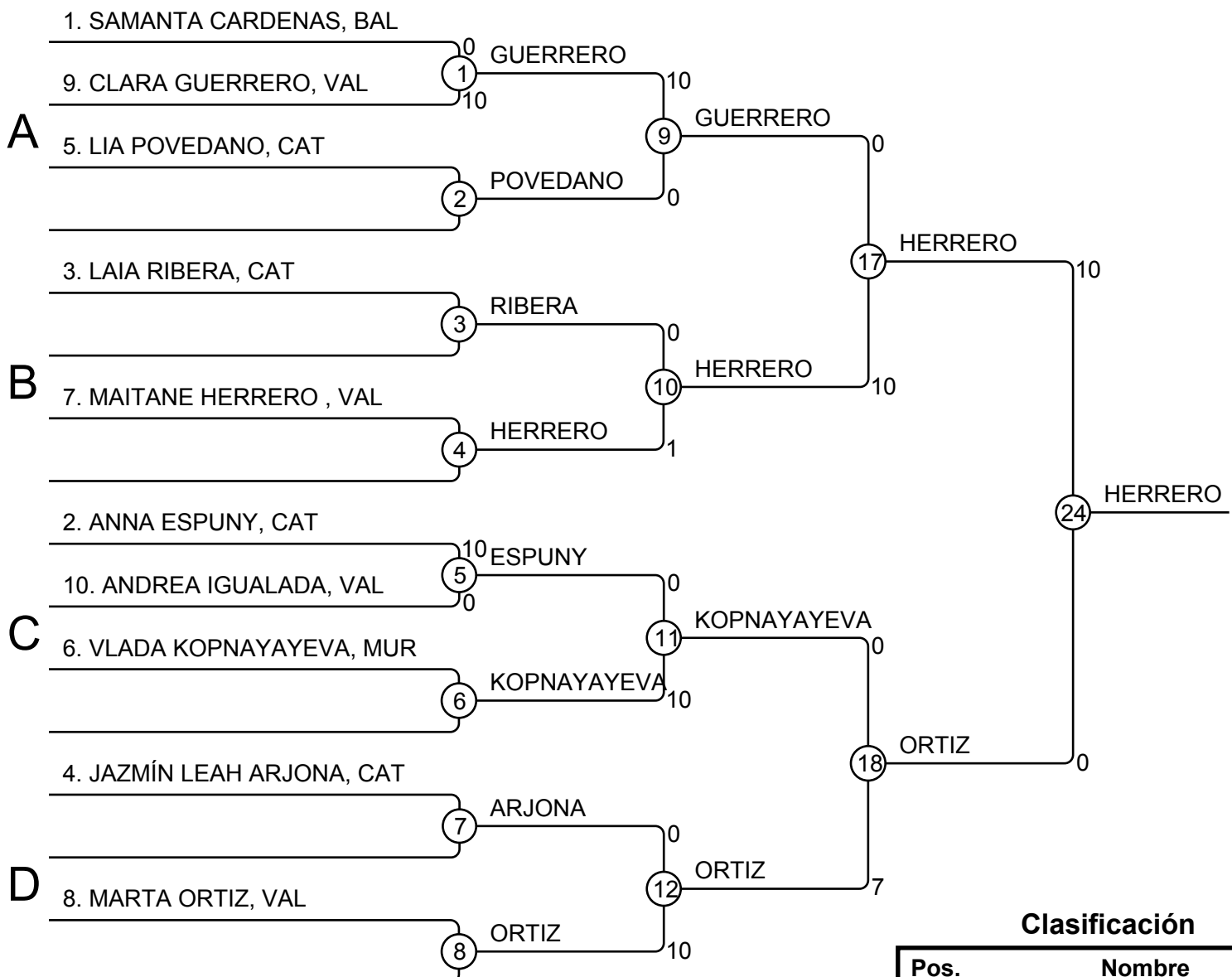

Clasificación

Pos.	Nombre
1	MAITANE HERRERO, VAL
2	MARTA ORTIZ, VAL
3	JAZMÍN LEAH ARJONA, CAT
4	VLADA KOPNAYAYEVA, MUR
5	LAIA RIBERA, CAT
5	CLARA GUERRERO, VAL

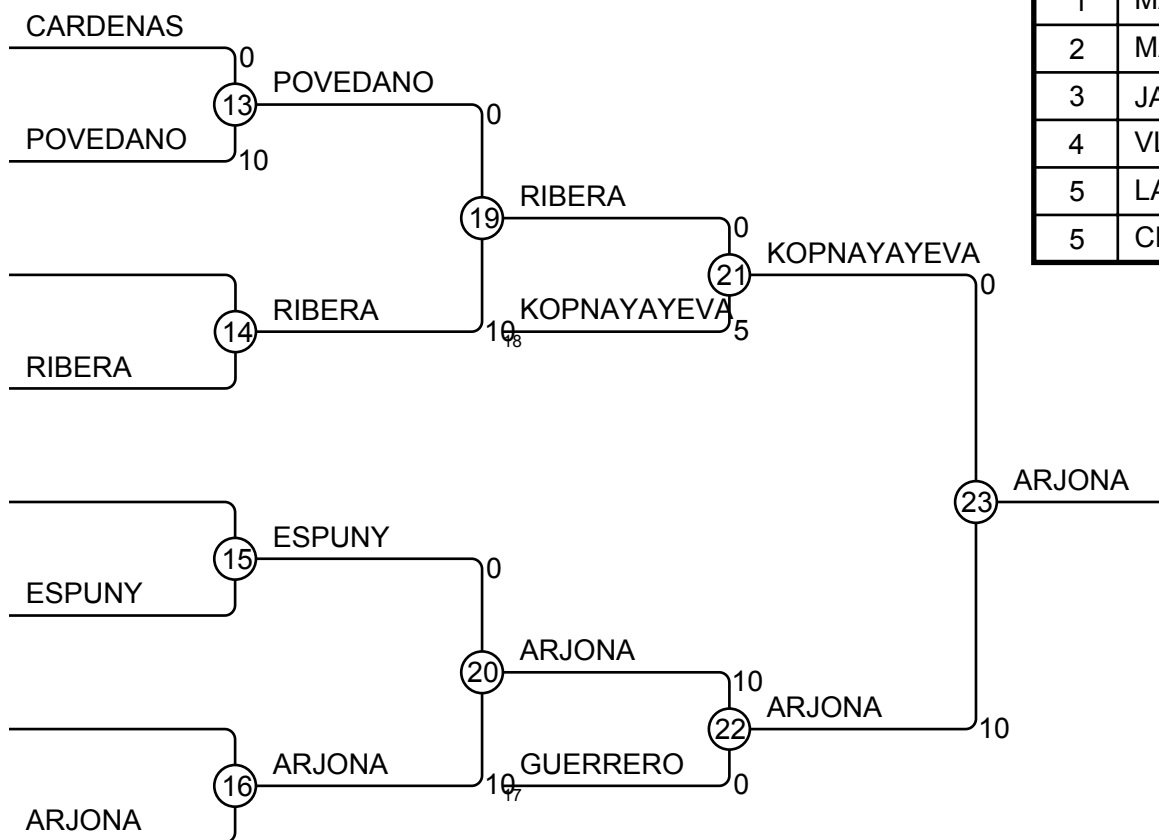

Sector Este C. de España Junior 2015 21-2-2015 F-70

Competidores: 9

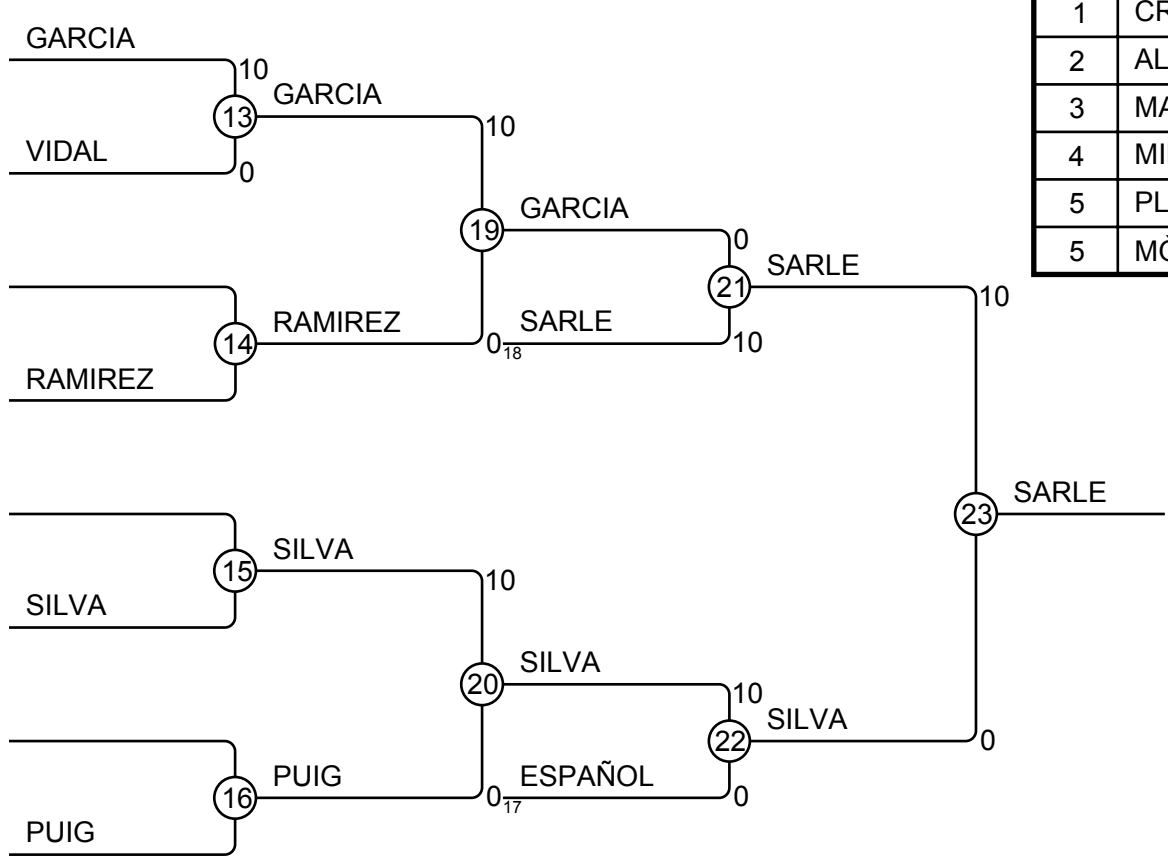
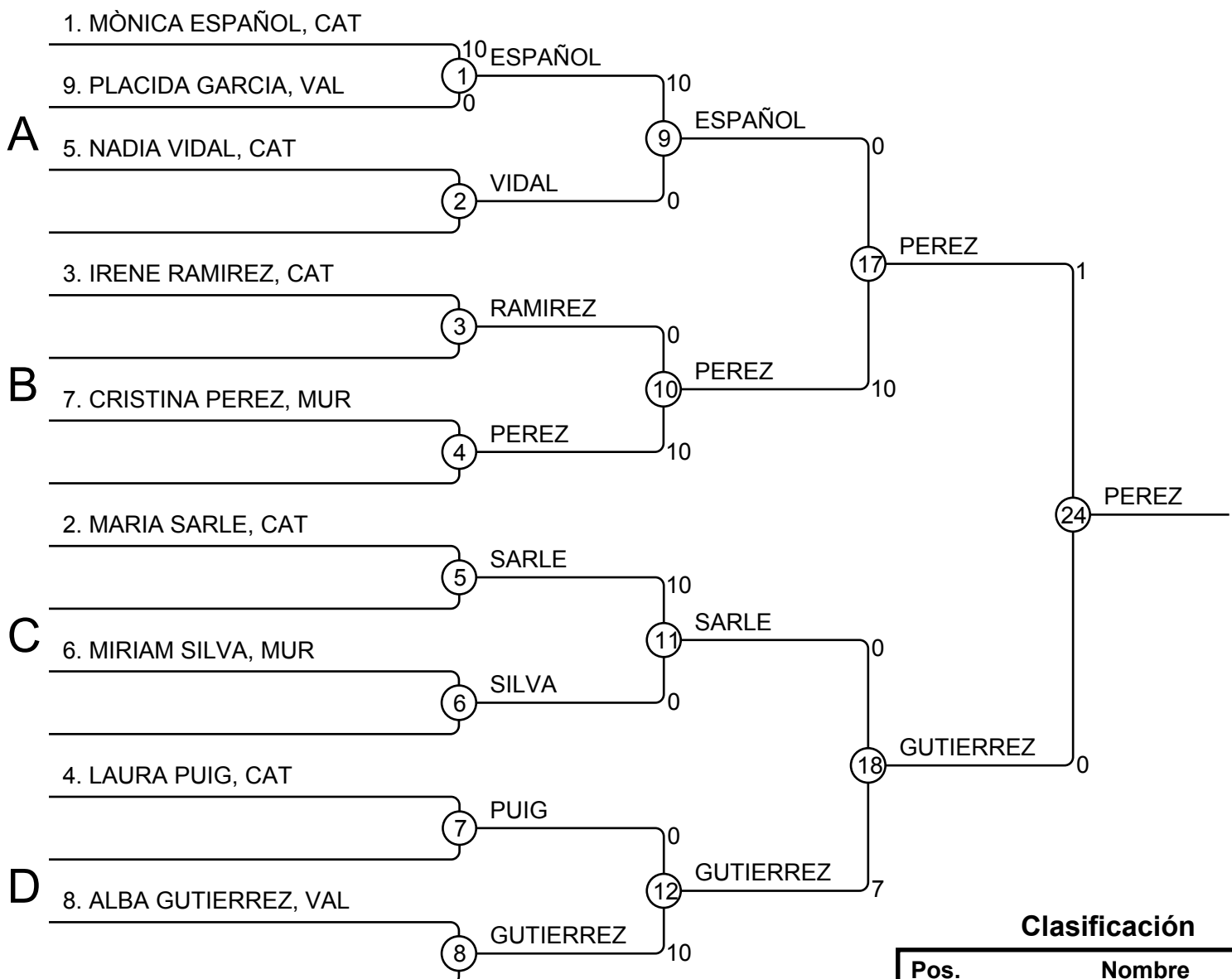

Clasificación

Pos.	Nombre
1	CRISTINA PEREZ, MUR
2	ALBA GUTIERREZ, VAL
3	MARIA SARLE, CAT
4	MIRIAM SILVA, MUR
5	PLACIDA GARCIA, VAL
5	MÓNICA ESPAÑOL, CAT

Sector Este C. de España Junior 2015 21-2-2015 F-78

Competidores: 1

Competidores

Nº	Nombre	Club	1	Victs.	Pts.	Pos.
1	LORENA LERA	MUR		0	0	1

Combates

Comb.	Blanco	Azul	Resultado	Tiempo
-------	--------	------	-----------	--------

Clasificación

Pos.	Nombre
1	LORENA LERA, MUR

Sector Este C. de España Junior 2015 21-2-2015 F+78

Competidores: 3

Competidores

Nº	Nombre	Club	1	2	3	Victs.	Pts.	Pos.
1	EVA FERNANDEZ	VAL				0	0	3
2	INMACULADA GARRIGUES	VAL	10			1	10	2
3	MARTA ANTÓN	CAT	10	10		2	20	1

Combates

Comb.	Blanco			Azul	Resultado	Tiempo
1	EVA FERNANDEZ	1	2	INMACULADA GARRIGUES	0 - 10	2:48
2	EVA FERNANDEZ	1	3	MARTA ANTÓN	0 - 10	0:33
3	INMACULADA GARRIGUES	2	3	MARTA ANTÓN	0 - 10	1:16

Clasificación

Pos.	Nombre
1	MARTA ANTÓN, CAT
2	INMACULADA GARRIGUES, VAL
3	EVA FERNANDEZ, VAL

Sector Este C. de España Junior 2015 21-2-2015 M-55

Competidores: 9

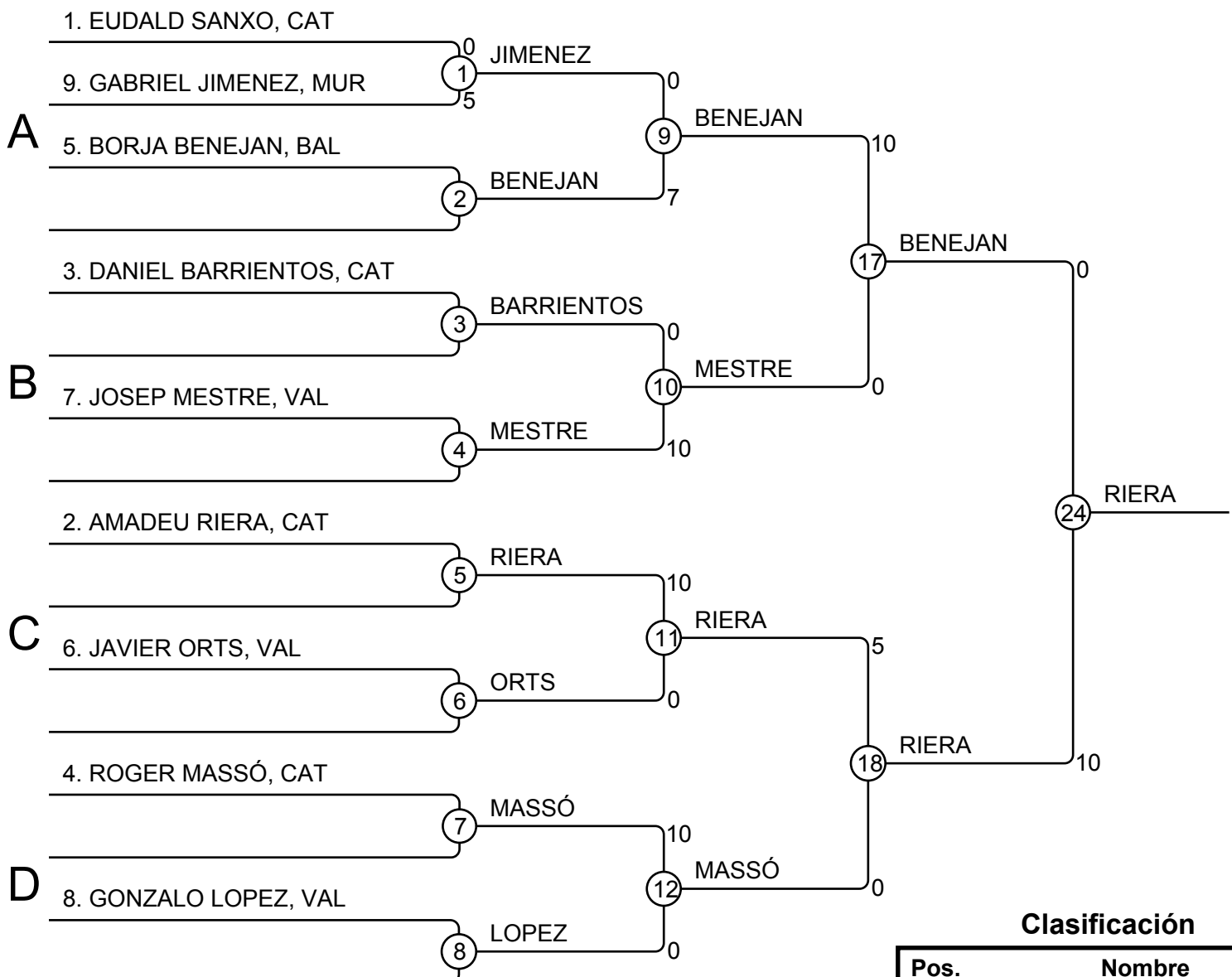

Clasificación

Pos.	Nombre
1	AMADEU RIERA, CAT
2	BORJA BENEJAN, BAL
3	GABRIEL JIMENEZ, MUR
4	GONZALO LOPEZ, VAL
5	ROGER MASSÓ, CAT
5	JOSEP MESTRE, VAL

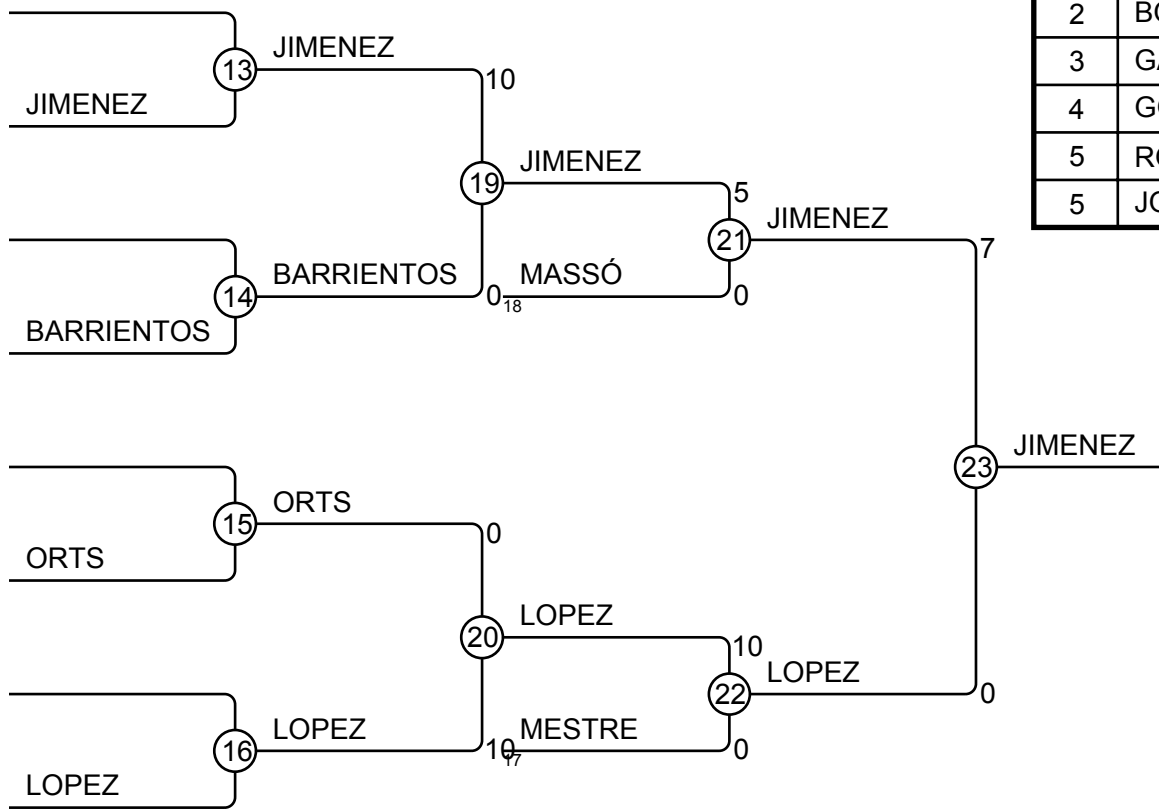

Sector Este C. de España Junior 2015 21-2-2015 M-60

Competidores: 10

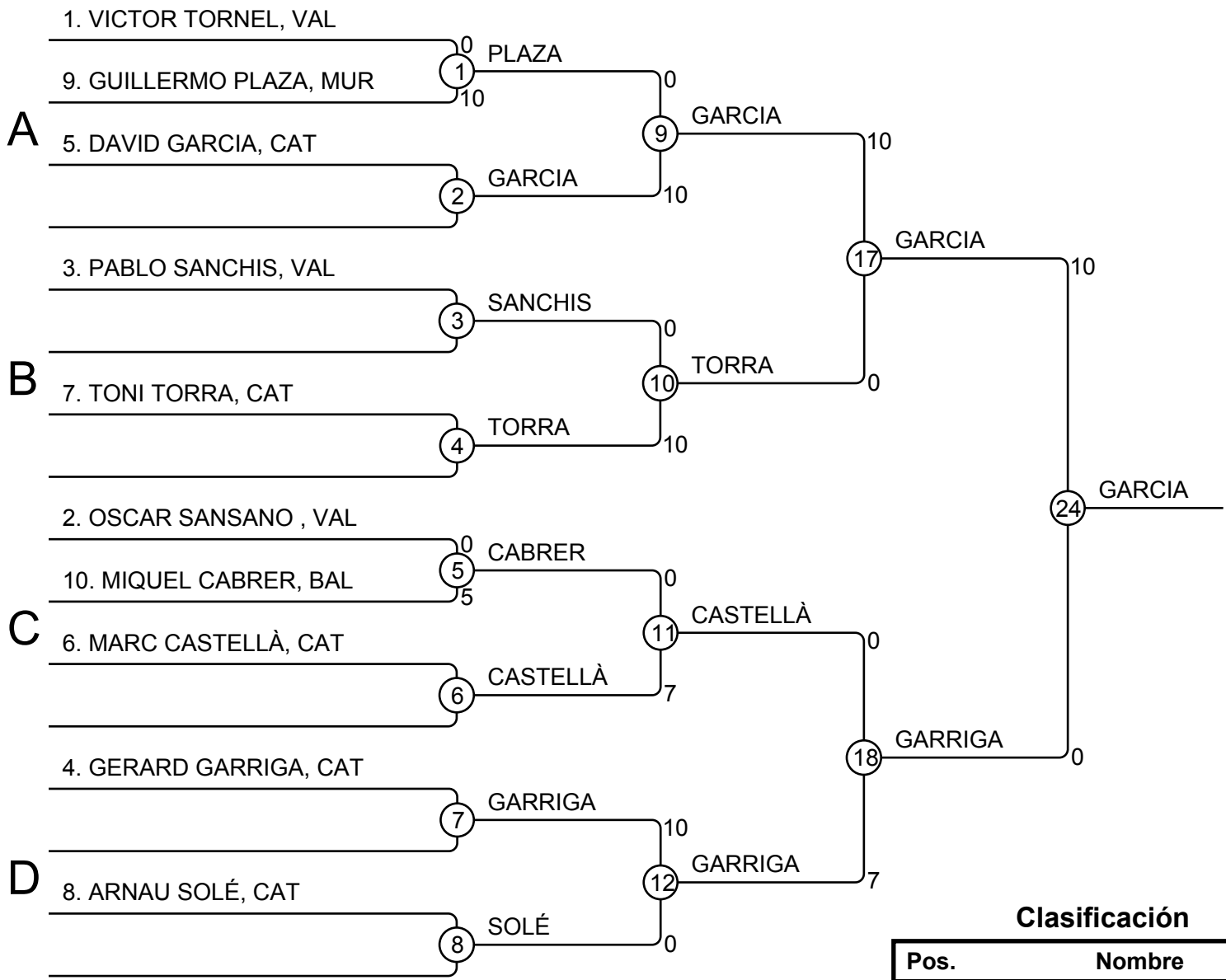

Clasificación

Pos.	Nombre
1	DAVID GARCIA, CAT
2	GERARD GARRIGA, CAT
3	MARC CASTELLÀ, CAT
4	TONI TORRA, CAT
5	GUILLERMO PLAZA, MUR
5	MIQUEL CABRER, BAL

Sector Este C. de España Junior 2015 21-2-2015 M-66

Competidores: 10

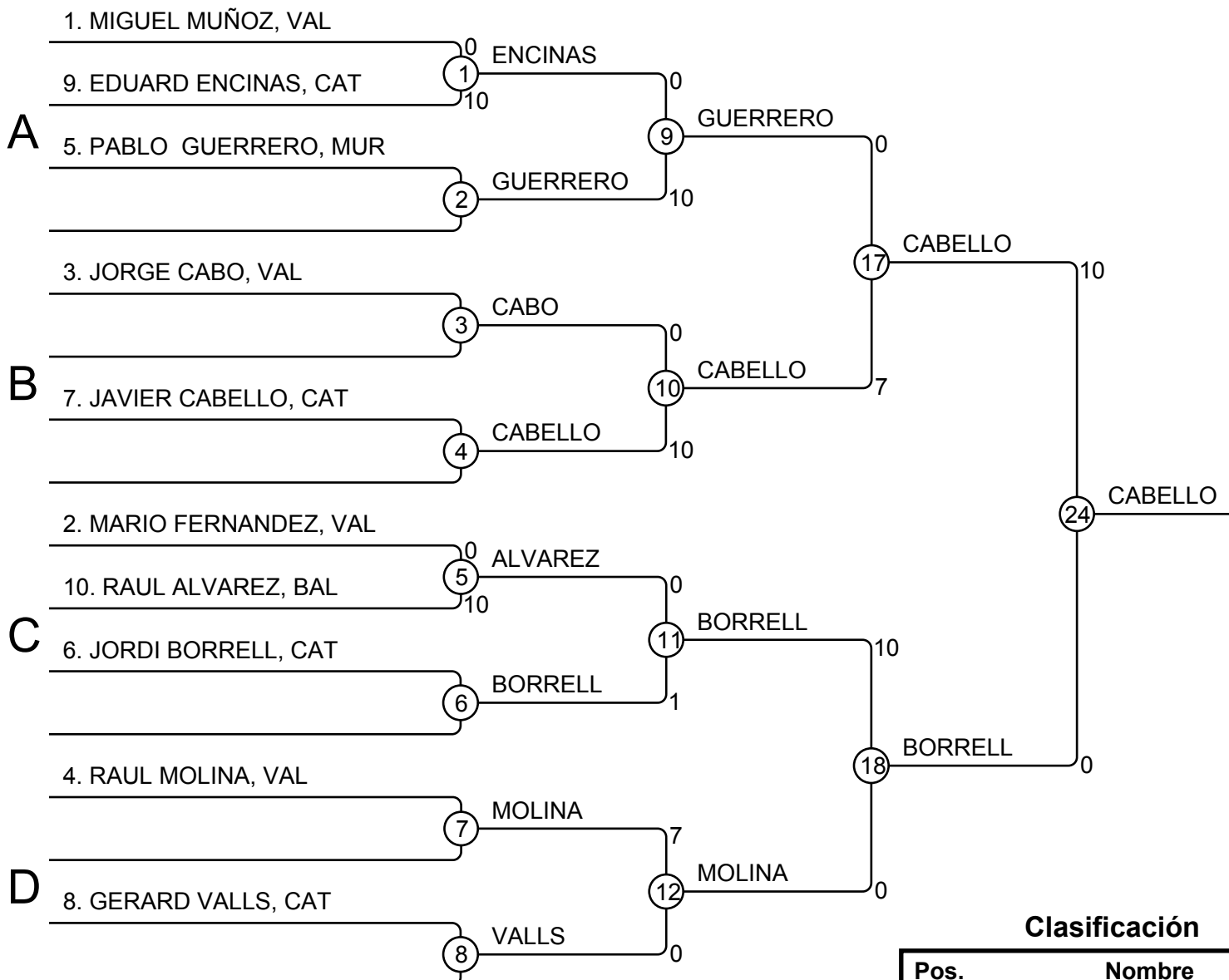

Clasificación

Pos.	Nombre
1	JAVIER CABELLO, CAT
2	JORDI BORRELL, CAT
3	RAUL MOLINA, VAL
4	PABLO GUERRERO, MUR
5	JORGE CABO, VAL
5	RAUL ALVAREZ, BAL

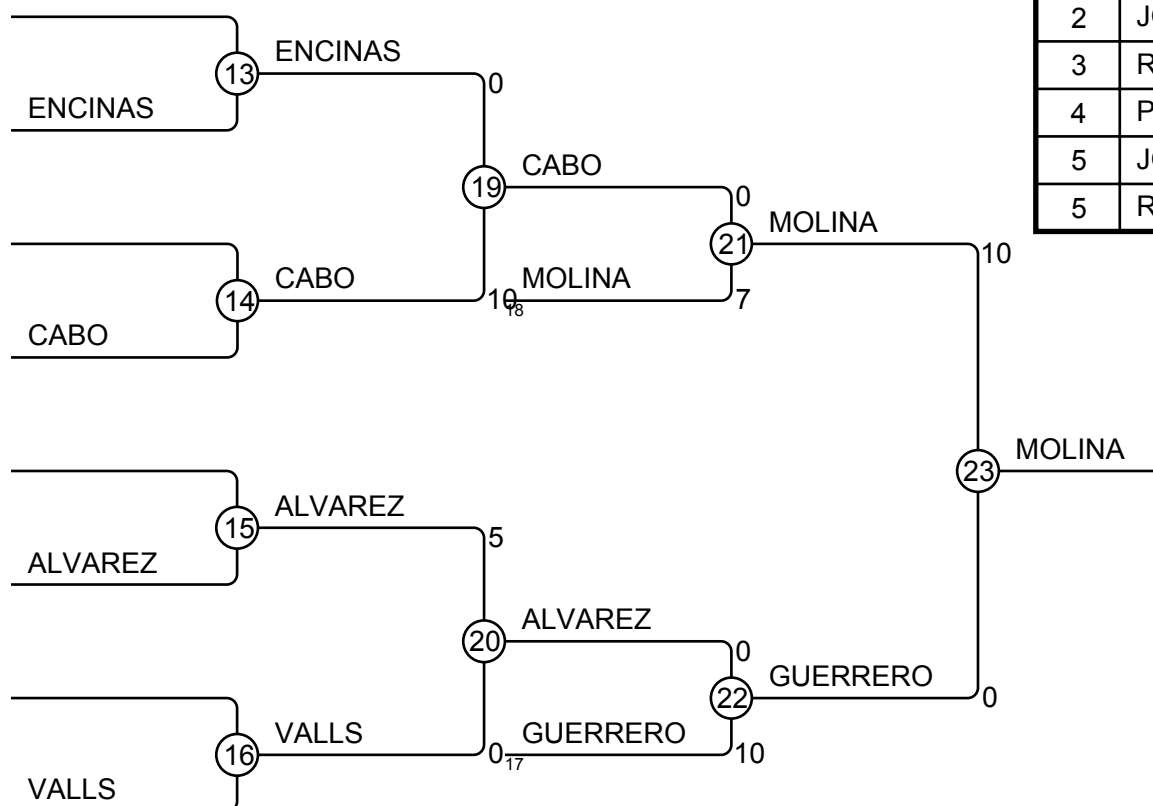

Sector Este C. de España Junior 2015 21-2-2015 M-73

Competidores: 10

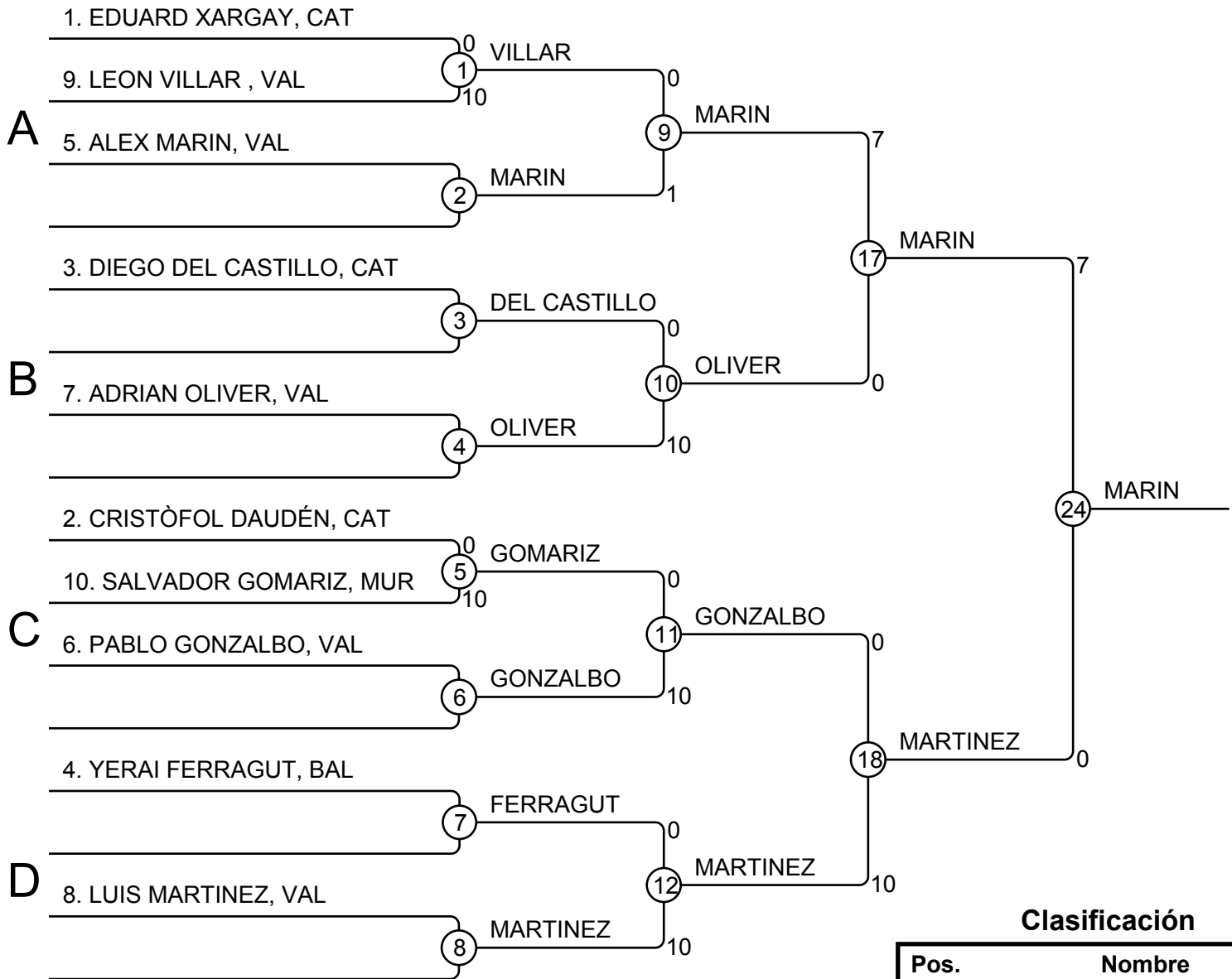

Clasificación

Pos.	Nombre
1	ALEX MARIN, VAL
2	LUIS MARTINEZ, VAL
3	ADRIAN OLIVER, VAL
4	DIEGO DEL CASTILLO, CAT
5	PABLO GONZALBO, VAL
5	SALVADOR GOMARIZ, MUR

Sector Este C. de España Junior 2015 21-2-2015 M-81

Competidores: 7

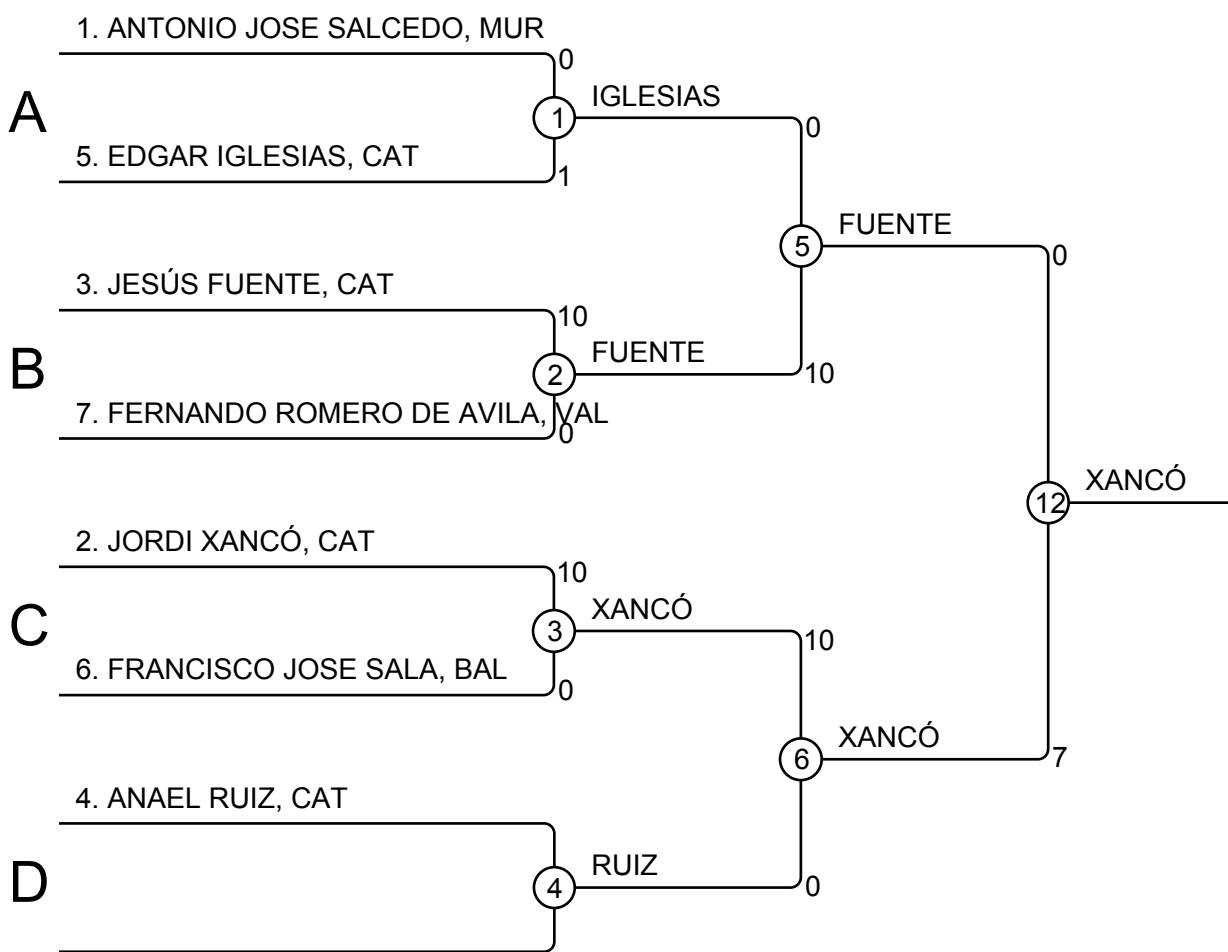

Clasificación

Pos.	Nombre
1	JORDI XANCÓ, CAT
2	JESÚS FUENTE, CAT
3	FERNANDO ROMERO DE AVILA, VAL
4	EDGAR IGLESIAS, CAT
5	ANAEL RUIZ, CAT
5	FRANCISCO JOSE SALA, BAL

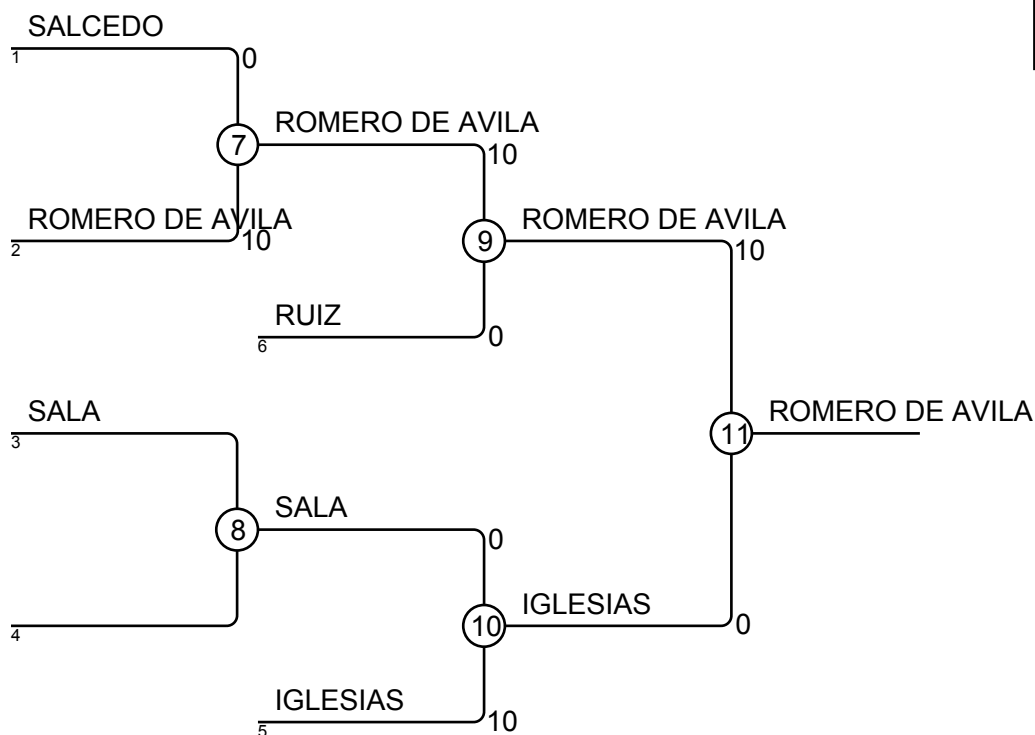

Sector Este C. de España Junior 2015 21-2-2015 M-90

Competidores: 9

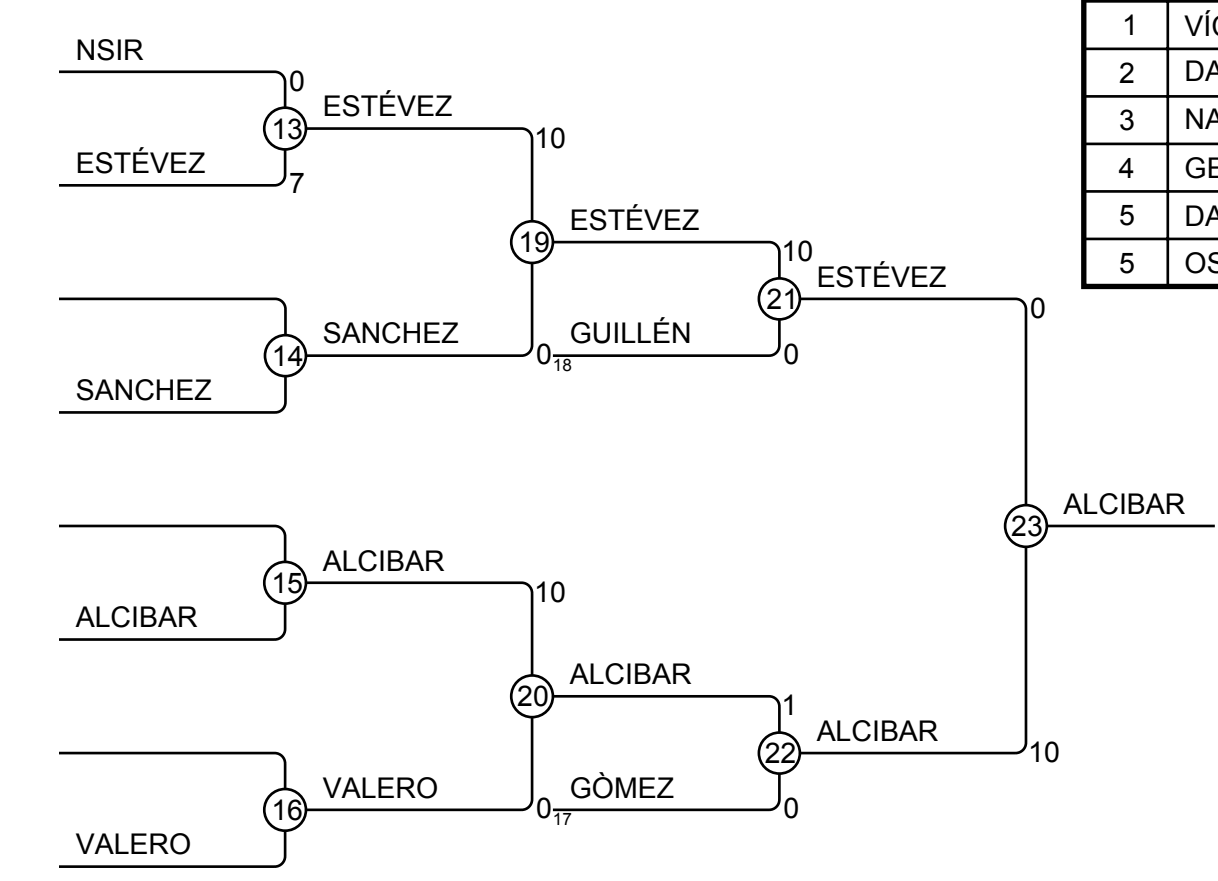
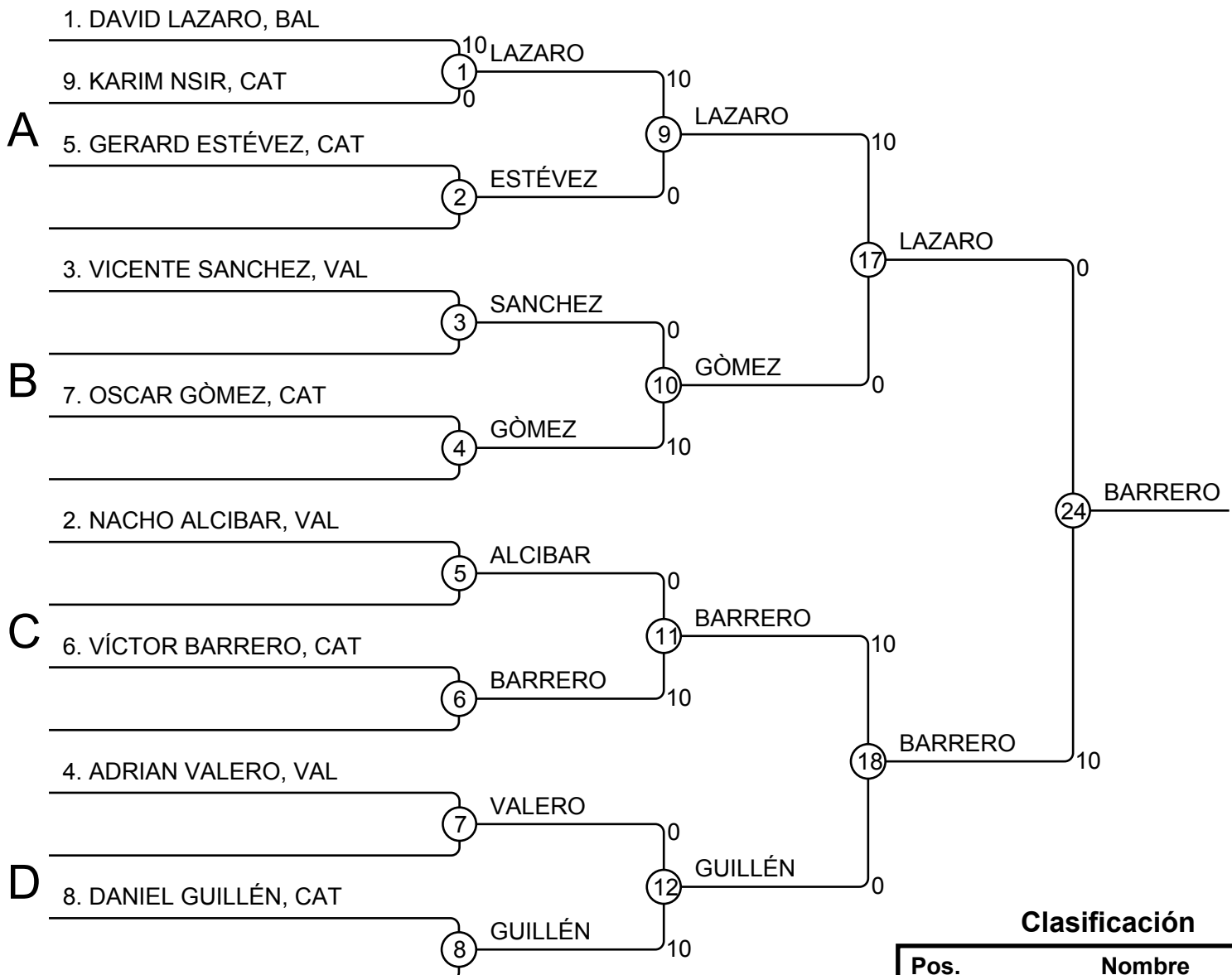

Clasificación

Pos.	Nombre
1	VÍCTOR BARRERO, CAT
2	DAVID LAZARO, BAL
3	NACHO ALCIBAR, VAL
4	GERARD ESTÉVEZ, CAT
5	DANIEL GUILLÉN, CAT
5	OSCAR GÒMEZ, CAT

Sector Este C. de España Junior 2015 21-2-2015 M-100

Competidores: 4

Competidores

Nº	Nombre	Club	1	2	3	4	Victs.	Pts.	Pos.
1	JORGE GALLEGO	CAT		10		10	2	20	2
2	MARC MARTÍ	CAT				10	1	10	3
3	SANDRO OTARASHVILI	VAL	10	5		10	3	25	1
4	MARTIN NAVARRO	VAL					0	0	4

Combates

Comb.	Blanco			Azul	Resultado	Tiempo
1	JORGE GALLEGO	1	2	MARC MARTÍ	10 - 0	0:29
2	SANDRO OTARASHVILI	3	4	MARTIN NAVARRO	10 - 0	4:00
3	JORGE GALLEGO	1	3	SANDRO OTARASHVILI	0 - 10	2:44
4	MARC MARTÍ	2	4	MARTIN NAVARRO	10 - 0	0:32
5	JORGE GALLEGO	1	4	MARTIN NAVARRO	10 - 0	1:39
6	MARC MARTÍ	2	3	SANDRO OTARASHVILI	0 - 5	4:00

Clasificación

Pos.	Nombre
1	SANDRO OTARASHVILI, VAL
2	JORGE GALLEGO, CAT
3	MARC MARTÍ, CAT
4	MARTIN NAVARRO, VAL

Sector Este C. de España Junior 2015 21-2-2015 M+100

Competidores: 2

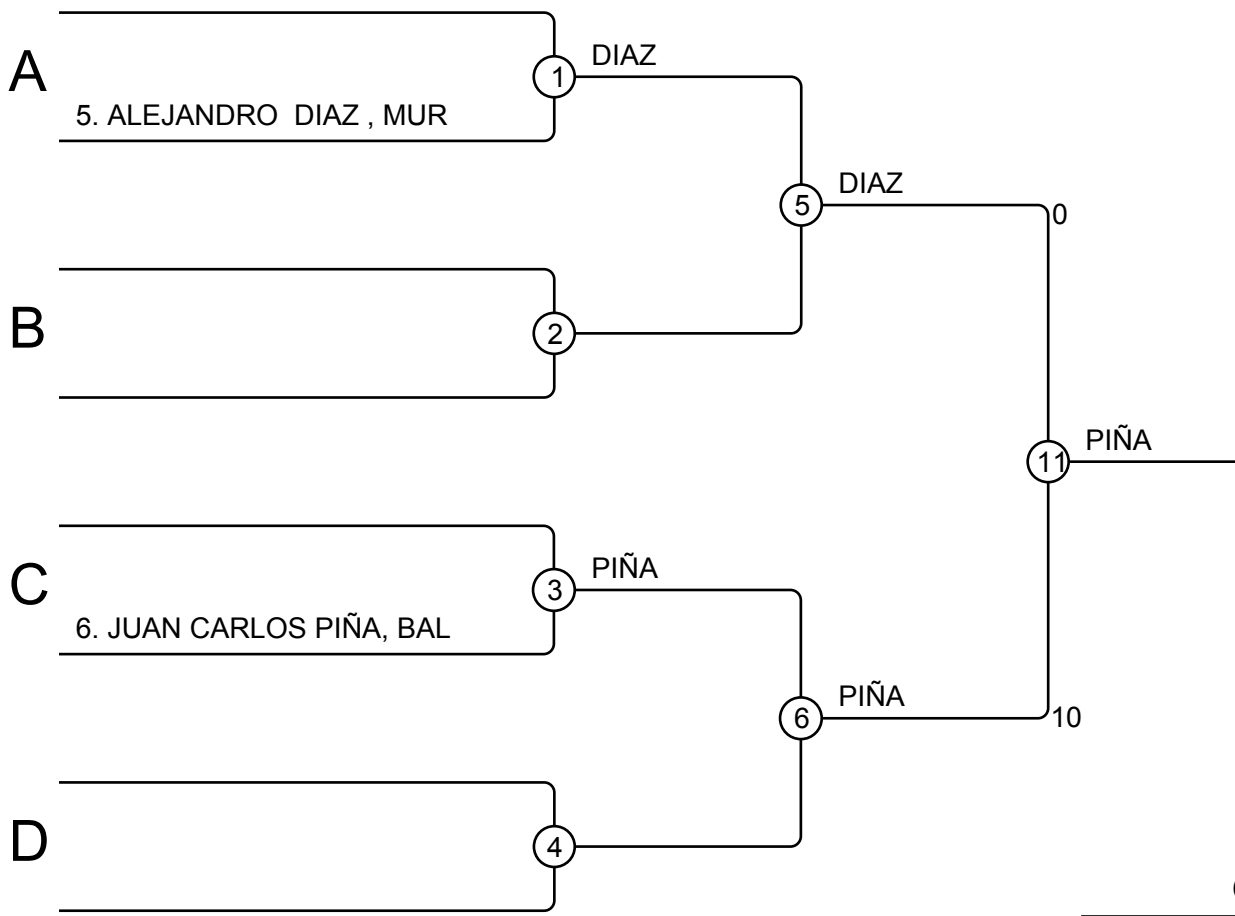

Clasificación

Pos.	Nombre
1	JUAN CARLOS PIÑA, BAL
2	ALEJANDRO DIAZ , MUR
3	
3	
5	
5	
7	
7	

